



## REOVIB

Control Equipment for the Vibratory Feeder Industry

MFS 268

Frequency Converter for Vibratory Feeders

UL / CSA - Version



**Technical safety instructions for the user**

This description contains the necessary information for the correct application of the product described below. It is intended for use by technically qualified personal.

Qualified personnel are persons who, because of their training, experience and position as well as their knowledge of appropriate standards, regulations, health and safety requirements and working conditions, are authorised to be responsible for the safety of the equipment, at all times, whilst carrying out their normal duties and are therefore aware of, and can report, possible hazards (Definition of qualified employees according to IEC 364)

**Safety Instructions**

The following instructions are provided for the personal safety of operators and also for the protection of the described product and connected equipment.



**Warning!**  
Hazardous Voltage  
Failure to observe can kill, cause serious injury or damage

- Isolate from mains before installation or dismantling work, as well as for fuse changes or post installation modifications.
- Observe the prescribed accident prevention and safety rules for the specific application.
- Before putting into operation check if the rated voltage for the unit conforms with the local supply voltage.
- Emergency stop devices must be provided for all applications. Operation of the emergency stop must inhibit any further uncontrolled operation.
- **The electrical connecting terminals must be covered!**
- **Earth bonding must be tested for integrity after installation.**

**Specified Use**

The units described herein are electrical controllers for installation in industrial plant. They are designed for controlling vibratory feeders.

**The Enclosed version (IP54) is not designed for control cabinet installation, this will be drastically shortening the lifetime.**

**Declaration of conformity**

We declare that these products conform with the following standards and directives:

Directives:	Standards:
2014/30/EU	EMC
2014/35/EU	LVD
2011/65/EU	RoHs
	EN 61000-6-4:2007 +A1:2011; EN 61000-6-2:2005
	EN 50178:1997



REO AG, D-42657 Solingen

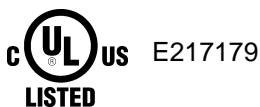

For use in NFPA 79 Applications only

Adapters providing field wiring means are available from REO AG.  
Refer to REO AG.

## Contents

Technical safety instructions for the user .....	2
Declaration of conformity .....	2
1.0 General .....	4
2.0 Function .....	4
2.1 Track control .....	5
2.2 Operating with two speeds (2 set points for coarse/fine switching) .....	5
2.3 Control inputs and output .....	5
2.3.1 Enable input .....	5
2.3.2 Sensor input for track control .....	5
2.3.3 External set point .....	5
2.3.4 Output status relay .....	6
2.3.5 Time-Out output 24 VDC .....	6
2.3.6 Air valve output 24 VDC .....	6
2.4 Display .....	6
3.0 Construction .....	6
3.1 Enclosed units .....	6
3.2 Panel mounting units .....	6
4.0 Technical Data .....	7
5.0 Ordering Codes (UL / CSA units) .....	8
6.0 Settings .....	9
7.0 Control elements .....	10
7.1 Settings .....	10
8.0 Commissioning .....	11
8.1 Assembling position .....	11
8.2 Preliminary steps .....	11
8.2.1 Important points .....	11
8.2.1.1 Operating frequency of the feeder coil .....	11
8.2.1.2 Measurement of the output voltage and current .....	11
8.3 Putting the equipment into operation .....	12
8.4 Switch-on frequency of the power supply .....	12
9.0 Setting Instructions .....	13
9.1 User adjustment of throughput .....	13
9.2 Tuning the feed system .....	13
9.2.1 Feeder settings .....	13
9.2.2 Track control .....	14
9.2.3 Sensor time out .....	14
9.2.4 Set point source .....	14
9.2.5 Pulse feed .....	15
9.2.6 Regulation mode .....	15
9.2.6.1 Instructions for using regulation mode .....	16
9.2.6.2 Mounting the accelerometer .....	16
9.2.6.3 Relationship between acceleration and amplitude .....	18
9.2.6.4 Instructions for setting up the controller in regulation mode .....	18
9.2.6.5 Determining the resonant frequency .....	18
9.2.6.6 Optimising controller in regulation mode .....	19
9.2.6.7 Displays .....	19
9.2.7 Display actual current and frequency .....	20
9.2.8 Save selected parameters .....	20
9.2.9 Recall user or factory settings .....	20
9.2.10 Hide parameter menus .....	20
10.0 Error messages / ERROR reset .....	21
11.0 Connections for enclosed construction (IP 54): 6-8 A Units .....	22
11.1 Connections for enclosed construction (IP 54): 12 A Units .....	23
11.2 Connections for enclosed construction (IP 54): 16 A Units .....	24
12.0 Connections for panel mounting construction (IP 20): 3 A, 6 A, 8 A .....	25
12.1 Connections for panel mounting construction (IP 20): 16A .....	26
13.0 Dimensions for 3 A, 6 A, 8 A Units .....	27
13.1 Dimensions of enclosed construction (IP 54) 12 A .....	28
13.2 Dimensions of enclosed construction (IP 54) 16 A .....	28
13.3 Dimensions of Panel mounting construction (IP 20) 16 A .....	29
A 1.0 Service appendix .....	30
A 2.0 Accessories / Spare Parts .....	33

## 1.0 General

The REOVIB MFS 268 range comprises special, adaptable controllers for use with vibratory feeders. The units generate an output frequency, to drive feeders, that is independent of mains frequency and so exact tuning with springs is not necessary. The feeders also run quieter because of the sinusoidal output signal. The adjusted output frequency corresponds to the mechanical vibrating frequency of the feed system. The optimum frequency setting for a feeder can be determined manually or automatically in regulation mode. Depending on the version, the controller can be used in regulation mode, working in conjunction with an accelerometer fitted to the feeder, to operate at resonant frequency. In this way a constant component feed rate that is unaffected by load changes can be achieved. In regulation mode the vibrating frequency is also dynamically adjusted to compensate for resonant frequency changes caused by load changes. In normal operating mode (without accelerometer) the feeder remains constant at the set frequency. In both operating modes the feeder throughput is determined by the output voltage level. Totally enclosed or panel mounting units can be supplied.

### Notable Features:

- Adjustable output frequency, independent of mains frequency
- Adjustable minimum and maximum limits for the frequency range
- Adjustable current limit for the maximum coil current
- Constant feeder throughput irrespective of mains fluctuations
- Regulation control, with independent frequency search (resonance)
- On/Off status relay
- Track control
- 24 VDC output for operating a solenoid e.g air valve
- Four user setting memory locations
- Optional RS232 or field bus for remote parameter setting.

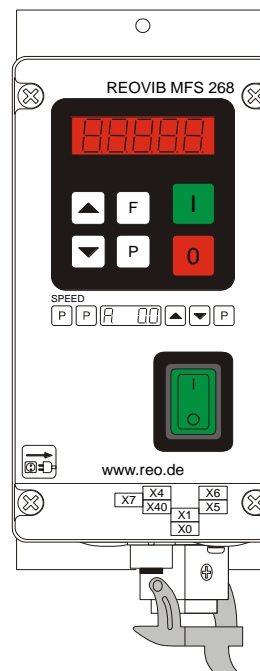

Enclosed  
Construction

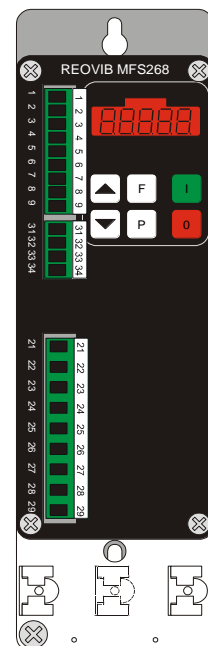

Panel mounting  
construction

## 2.0 Function

The unit is set up by using the touch panel on the front plate (buttons and LED display). All settings can be made by using the touch panel and a series of menus. The various parameters can be selected by entering operator codes. A fuller description of the parameters can be found in the section on settings. Alternatively, the feeder throughput can be adjusted by using an external potentiometer, an external voltage signal 0...10 V, DC or a current signal 0(4)...20 mA (the chosen option must be selected in menu 003). A relay with potential free contacts is provided for feeder status indication and this operates in conjunction with the feeder enable signal. Terminals for these contacts can be found inside the controller.

During normal operation the set point is displayed as a percentage in the LED window. In the programming mode the selected dimension, as described in the setting up instructions, is shown. Changed settings can be stored by leaving the programming mode or automatically saved by not pressing a key for a period of 100 seconds. The control units can provide a frequency range from 5...300 Hz, which can be limited by adjustable, upper and lower frequency limits. The usable adjustment range cannot exceed a ratio of 1:4, i.e. the upper frequency limit cannot be more than four times the lower frequency limit. It is possible to have a narrower setting of the limits and this provides a margin of safety against too wide a difference in the vibrating frequency. The maximum output current drawn by the coil can be determined by integrated current limiting. Critical parameters such as the current limit and vibrating frequency range are held under a special service menu. This menu cannot be accessed through the normal menu structure and an additional code number has to be used to gain access. This prevents unauthorised adjustment of these sensitive parameters.

An interface option can be used to provide an RS232 or Fieldbus connection.

## 2.1 Track control

The output can be switched ON and OFF from a track component sensor, using internal, adjustable time delays (ton and toff).

The queue of components rises above and drops below the track sensor position. The controller

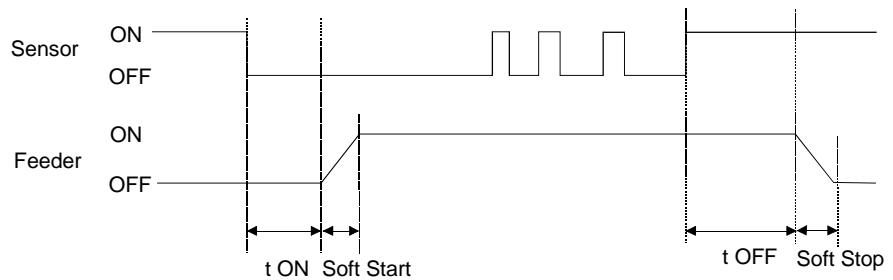

output switches on when the sensor cannot detect product and a switch-on time delay has elapsed. The output is switched off when product is detected and a switch-off time delay has elapsed (FULL displayed in the LED window). Gaps in the product feed cause resetting of the time delay. The time will always be precise from the last or first component, respectively. The ON and OFF time delays are set in the programming menu. The first decimal point in the display blinks to indicate that an internal timer is running. An additional "Sensor-Time-out" timer is started when the feeder switches on. This can be set (30...240 sec.) to switch off the feeder if no product is sensed in the time out period. The status relay indicates that the feeder is not running and the LED window displays ERROR and SE alternately. This function is optional and must be selected in the Track Settings Menu with function EEn = 1.

## 2.2 Operating with two speeds (2 set points for coarse/fine switching)

Coarse/Fine control can be used instead of track control (Menu C 003). The second set point is activated through the same sensor input that is used for track control. Either contacts or a 24 VDC signal can be used to change the set point from coarse to fine. The second set point is activated, immediately, by applying a 24 V signal  
(The track control function is invalid)

## 2.3 Control inputs and output

### 2.3.1 Enable input

External switch or 24 VDC signal voltage.

External control function to switch the power output ON or OFF e.g. Networking of several controllers from a central PLC.

### 2.3.2 Sensor input for track control

Sensor for monitoring the queue of components on the track or an input for switching to the second set point 24 VDC (PNP).

### 2.3.3 External set point

The feeder amplitude set point can be provided from an external, analog 0...10 V, DC, 0(4)...20 mA, or a 10 kR Potentiometer. Parameter ESP in Menu C003 must be set to I, for an external set point source to be used.

If a potentiometer is used, must additionally parameter "POT" set to I. (not on 16A IP 20 units).

Setting the minimum output value when external set point = 0:

Before changing the ESP parameter to accept an external set point source, the minimum value can be adjusted by using the cursor keys, on the front panel, and this will remain when the ESP is changed over from 0 to I.

### 2.3.4 Output status relay

Status-Relay contact 250 V/1 A (changeover). Relay closes when the feeder is running – the relay opens when there is no enable signal or a fault displayed.

### 2.3.5 Time-Out output 24 VDC

"time Out" message active, if after adjusted time no material is recognized by the sensor (adjustable with parameter "E."). (not on IP 20 units)

### 2.3.6 Air valve output 24 VDC

Output for air blast, comes on with feeder and switches off, 4 sec., after feeder stops (not on IP 20 units)

## 2.4 Display

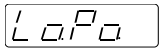

Initialisation phase, when supply voltage is connected (left decimal point blinks).

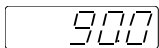

Normal Mode: The throughput set point is displayed

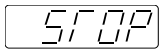

Output switched off using the `0` button

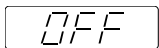

Unit inhibited by the enable input



Output switched off by the track control sensor

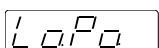

Under voltage, input voltage is too low.

## 3.0 Construction

The units are available as stand-alone, enclosed or panel mounting versions .

### 3.1 Enclosed units

- Mains switch
- Touch panel with display
- Mains cable with plug
- Output cable or output socket for connecting to the feed system
- Sensor socket. The standard unit has provision for 24 VDC sensors with a PNP output

### 3.2 Panel mounting units

- Touch panel with display
- Terminals for electrical connections
- Screw hole fixings for mounting

#### 4.0 Technical Data

Model Type	MFS 268 / 3A	MFS 268 / 6A	MFS 268 / 8A	MFS 268 / 12A	MFS 268 / 16A
Supply voltage	110 VAC, 240 VAC +/- 10 %, 50/60 Hz				
Output voltage	0...95 V, 0...205 V				
Output frequency	5...300 Hz (Default setting: 35...140 Hz)				
Output current max.	3 A	6 A	8 A	12A	16 A
Power loss	25 W	45 W	57 W	83 W	110 W
Input current max. at 230 V supply	1,6 A	3,7 A	4,4 A	6,6 A	8,7 A
Input current max. at 110 V supply	2,4 A	5,1 A	5,8 A	9,6 A	13,1 A
Recommended * fuse	10 A Time-lag	16 A Time-lag			
	Type D current trip device				
Enable	24 V, DC input (connect to internal 24 V reference)				
Status relay	Change-over contacts, 250V, 1 A				
Sensor supply	24 V, DC, 100 mA				
Sensor type	PNP output				
Status output	Relay, change-over contact 1A, 250 VAC , 60 VDC				
Switch-on frequency of the power supply	wait 5 seconds until resetting the power supply				
Solenoid valve out- put (not provided at IP 20 versions)	24 VDC / 50 mA switched with feeder unit (PNP), short-circuit protected				
Operating tempera- ture	0...+45 °C				
Storage temperature	-10...+80 °C				
Altitude	1000 m 0,5 % rated current reduction for each additional 100 m				

\* The units are provided with switch-on, current damping. However it is still possible that some internal capacitor, energising, current spikes will be generated, especially when several units are switched on simultaneously. Therefore, fuses and overload trips should have anti current surge characteristics.

## 5.0 Ordering Codes (UL / CSA units)

### Switch cabinet design (IP20)

Designation	Order. no.	Output current	Control connections*	Power output	Power input
REOVIB MFS 268 / 3A - IP20 - UL	200621607	3A	Screw terminals	Screw terminals	Screw terminals
REOVIB MFS 268 / 6A - IP20 - UL	200621614	6A			
REOVIB MFS 268 / 8A - IP20 - UL	200621621	8A			
REOVIB MFS 268 / 16A - IP20 - UL	200621110	16A			

**\*Control connections:**

- Level sensor connection
- Status relay
- Enable input
- External setpoint 0-10V, 0(4)-20mA
- Vibration sensor connection

### Ordering Codes: Housing design (IP54)

Designation	Order. no.	Output current	Control connections*	Power output	Power input
REOVIB MFS 268 / 6A - IP54 - UL	200626825	6A	X4, X5, X6, X7, X40	Pluggable (Harting)	Pluggable (Harting)
REOVIB MFS 268 / 8A - IP54 - UL	200626845	8A			
REOVIB MFS 268 / 12A - IP54 - UL	200626865	12A			
REOVIB MFS 268 / 16A - IP54 - UL	200626885	16A			

**\*Control connections:**

- X4= Level sensor connection
- X5= Status-/Timeout output
- X6= Enable input
- X7= blowing air output
- X40= Vibration sensor connection



## 6.0 Settings

After checking the correct operation of the controller in conjunction with the vibratory feed system it is advisable to restrict the user to feeder throughput settings only.

Setting the feeder throughput:

**Press the P key twice and adjust the throughput with the cursor keys (Code C. 000).**

Parameter:	Code	Factory setting:	Entry Code:
<b>Vibratory feeder</b>			
• Amplitude (throughput)	0...100 %	A.	0 %
			000, 002

The following variable parameters are available for setting up the feed system

Parameter:	Display	Factory setting:	Entry Code:
<b>Vibratory feeder</b>			
• Amplitude (throughput)	0...100 %	A.	0 %
			000, 002, 020, 096
• Maximum control limit ( $U_{max}$ )	5...100 %	P.	90 %
			008, 020, 096
• Vibrating frequency	30...140 Hz (5...300 Hz)	F.	100 Hz
			008, 020 040, 096,
• Soft start ramp up	0...60 Sec.	/.	0.1 Sec.
			020, 096
• Soft stop ramp down	0...60 Sec.	\.	0.1 Sec.
			020, 096
• Switch to external set point	0 / 1	E.S.P.	0
			003
• Set point 0(4)...20 mA	0 / 1	4.20	0
			003
• Potentiometer set point	0 / 1	POT.	0
			003
• Coarse / Fine control	0 / 1	S.P.2.	0
			003
• Invert enable	0 / 1	-En.	0
			003
• Pulse feed	0 / 1	HOP.	0
			004, 064
• On time delay (only if HOP. = 1)	0...60 Sec.	H.	1.0 Sec.
			004, 064
• Off time delay (only if HOP. = 1)	0...60 Sec.	h	1.0 Sec.
			004, 064
• Invert hopper sensor (not active)	0 / 1	-Ho.	0
			004, 064
<b>Regulation (with sensor)</b>			
• Switch to regulation	0 / 1	ACC.	0
			008
• P characteristic	0...100	P.A.	40
			008
• I characteristic	0...100	I.A.	100
			008
• Automatic frequency control	0 / 1	A.F.C	0
			008
• Start automatic frequency search		A.F.S.	
			008
<b>Track control</b>			
• Switch on time delay	0...60 Sec.	I.	1.0 Sec.
			007, 167
• Switch off time delay	0...60 Sec.	O.	1.0 Sec.
			007, 167
• Invert sensor	PNP / PNP invert	-SE.	PNP
			007, 167
• Sensor Time-out	0 / 1	E.En.	0
			015, 167
• Sense time delay (Sensor Time-out)	1...240 Sec.	E.E.	180 Sec.
			015, 167
• Switch off time air valve	0...60 Sec.	A.i.	4 Sec.
			015
<b>Service</b>			
• Display actual output current		i.	
			040
• Display actual frequency		F.	
			040
• Save user settings		PUSH.	
			143
• Recall factory settings		FAC.	
			210
• Recall user settings		US.PA.	
			210
• Hide programming menus	0 / 1	Hd.C.	0
			117
• Hide set point adjustment	0 / 1	di.S.	0
			137
• Display software version			
			001

**7.0 Control elements**

**7.1 Settings**

The six buttons and a LED display found in the front panel, are used for operating and setting up the unit. All operating methods and adjustable parameters can be set up through this panel.

The "I" and "O" buttons are used for switching the unit ON and OFF, however, these do not provide mains isolation, they simply inhibit the power semiconductors

The "P", "F" and "Cursor Buttons" are used for parameter adjustment. Parameters are set by using menu controls which are called up by entering operator codes. The functions are described in greater detail in the section on setting instructions.

The display value can be increased or decreased by units, or tenths of units, by a short press of the cursor buttons. Holding the buttons down will cause the display to change in units of ten.

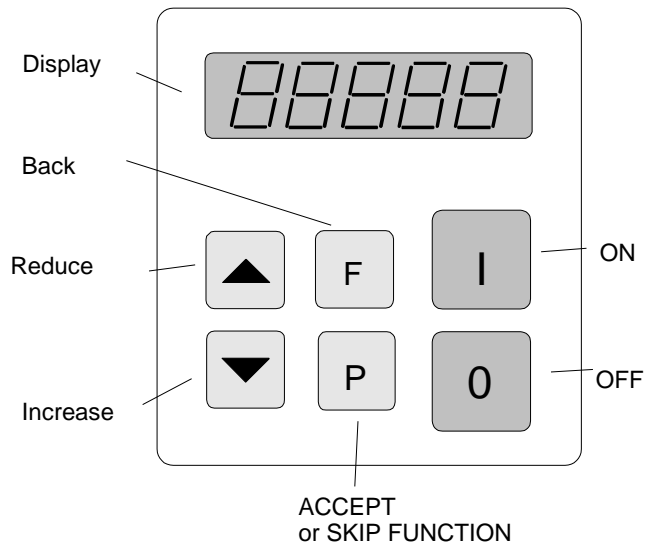

To prevent accidental or unauthorized adjustment the adjustment parameters, in the user menus, are protected. A code must be entered to open the user menus. There are different pass codes for each function group.

**Setting adjustments are automatically saved upon leaving the programming mode or if no button is pressed for a period of 100 seconds.**

All setting routines are commenced by pressing the programming button "P". The following diagram should clarify the sequence in which keys are pressed:

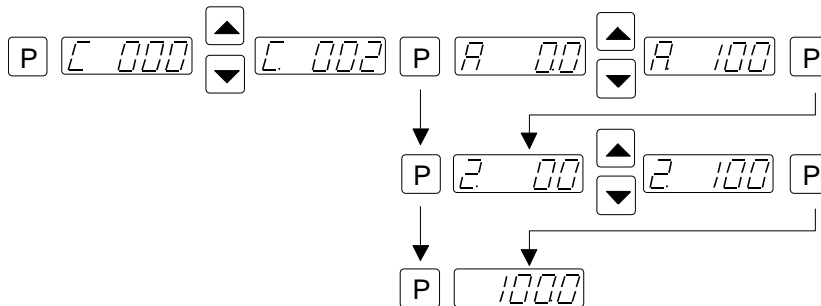

1. Press the "P" key.
2. Select the code number with the cursor keys.
3. Press the "P" key. This displays the first menu point. The required menu point can be found by repeatedly pressing the "P" key (scrolling).
4. The value in the menu point can be changed with the cursor keys.
5. Scroll to the next menu point or to the end of the menu, which returns the display to the set point value, by pressing the "P" key. To exit the menu and return back to the normal display, quickly, depress the "P" key for 5 seconds.
6. To return back to the previous position in the menu, press the "F" key.

## 8.0 Commissioning

### 8.1 Assembling position



Please fasten the devices on a vibration-free underground and take care for sufficient air circulation.

**The Enclosed version (IP54) is not designed for control cabinet installation, this will be drastically shortening the lifetime.**

### 8.2 Preliminary steps

- Check that the unit is correct for the local mains supply (rating plate information) and that it is correctly rated for the feed system.
- Connect the controller according to the connection diagram
- When applications with frequently on and off cycles are required, use the intended enable input. It is prohibited to open the current circuit with a switch or a contactor while the feeder is running.

#### 8.2.1 Important points



Using the control units described in this document, it is possible to adjust the feed system that it runs in resonance. In this condition it is possible to obtain excessive output for a very low set point setting. Therefore extreme care should be taken to avoid causing damage to the drive coil, through hammering.

In practice it is not possible to run at resonant frequency without accelerometer feedback because the system would be unstable and uncontrollable. The system must be set safely off resonance i.e. either above or below the natural frequency.

**Resonant frequency:** Depending on the spring and mass design of the feeder system it is possible to have resonance at more than one frequency. These additional resonance points are multiples of the main frequency. For this reason in critical situations it is possible that the automatic frequency search will not find true resonance and in such cases the natural frequency must be determined manually.

##### 8.2.1.1 Operating frequency of the feeder coil

It is possible that the current flowing through the coil will increase for a small frequency adjustment. And so this should be checked with a true RMS instrument for each new application as well as monitoring the coil for heat build-up.

The coil should be designed for the correct operating frequency to prevent excessive current draw and the consequential overloading of the coil.

##### 8.2.1.2 Measurement of the output voltage and current

The voltage and current cannot be measured with a regular instrument because the controller output uses an electronic inverter with a pulse width modulation signal. An effective measuring instrument such as a moving iron meter (analog) must be used. It is recommended that an analog instrument is used rather than an electronic multi-meter which will give a misleading reading.

### 8.3 Putting the equipment into operation

1. Establish the vibrating frequency.
2. Establish the power of the feed system (maximum permissible current draw).

For a new feeder where settings are unknown: (see also comments below)

**Without connecting the feeder**, select parameter FAC in menu C210 (reset factory settings), press the cursor key to reset (SAFE) and press the P key to leave the menu. The factory settings are listed in the table in section 7, headed settings

**! Comments !**

It is possible that a special parameter set, for a machine manufacturer, has been pre-stored under a user code and these can be recalled. In such instances specific machine settings will be loaded and so the next steps are not relevant.

Basic settings:

- Connect feeder.
- Set frequency (refer to feeder data sheet). Menu C096 parameter F.
- Check current limit (refer to feeder data sheet). Menu C040 parameter I (shows the current limit as a percentage of maximum). If applicable use service menu for setting.
- Increase set point, observe feeder, check running.
- Increase set point to maximum and check if power needs limiting (hammering). If necessary adjust the limit as follows:-
- Adjust set point to zero
- Set parameter P (maximum limit) in Menu C096 to 50
- Adjust set point A to 100%.
- Increase the maximum limit P from 50% until the required amplitude is reached.
- The full set point range of 0...100% can now be used.

Additional settings e.g. soft start, time delays etc. can be set to suit the particular equipment.

**Determining the output frequency (vibrating frequency)**

It is essential that the output frequency is adjusted with the set point set at a low frequency, otherwise on hitting the resonant frequency it is possible to achieve a high amplitude with a low output voltage. An analog, effective value, current indicating unit (moving iron meter) must be connected into the output circuit.

**Resonant is reached when there is a maximum amplitude for a minimum output current.**

**To achieve a stable feed system there must be an offset between the vibrating frequency and resonance (approx. 1...2Hz).** This offset must be determined by the user because different feeders have different running characteristics.

### 8.4 Switch-on frequency of the power supply

Please wait about 5 seconds until resetting the power supply to reduce not the efficiency of the internal inrush current limiter.

## 9.0 Setting Instructions

### 9.1 User adjustment of throughput

Code C. 000

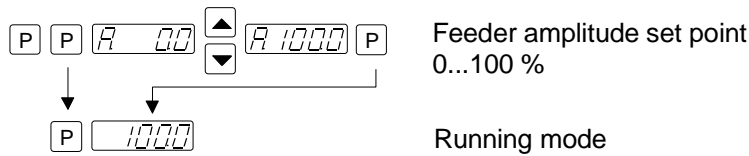

A further set point code can be found under C002  
(for use in coarse/fine operation)

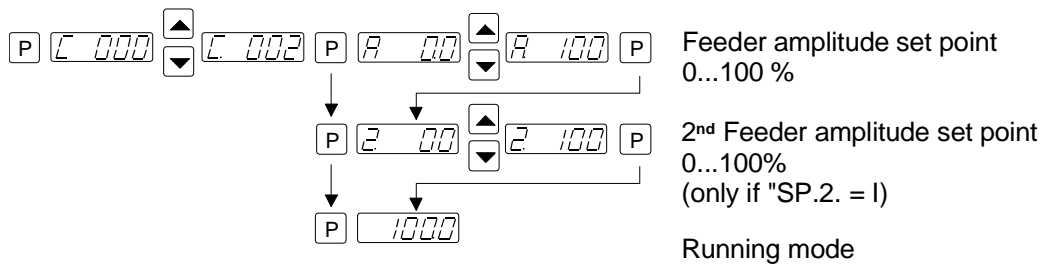

## 9.2 Tuning the feed system

### 9.2.1 Feeder settings

Code C. 020, 096

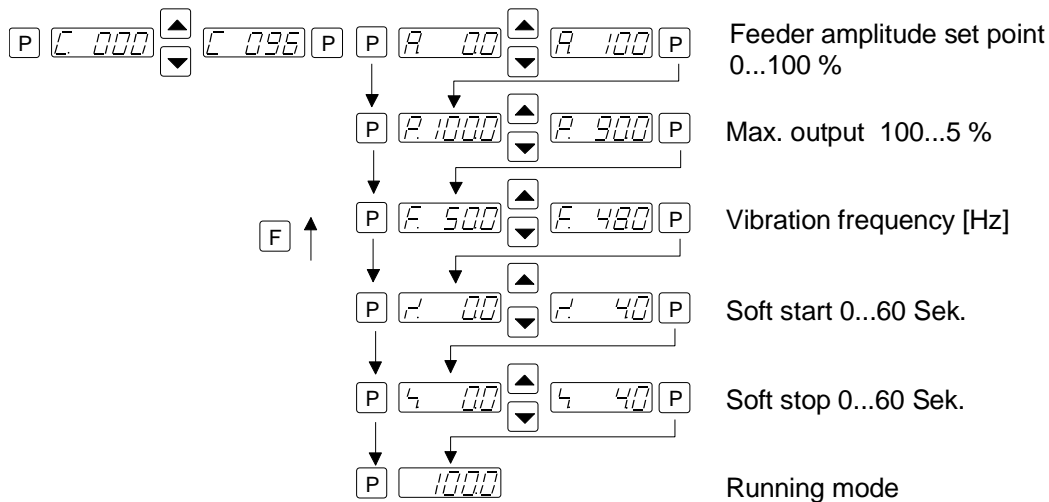

Setting the maximum limit

1. Adjust set point to zero
2. Set parameter P (maximum limit) to 50.
3. Adjust set point to 100%
4. Increase the limit P from 50% until the required amplitude is reached
5. The full set point range of 0...100% can now be used

### 9.2.2 Track control

Code C. 167, 007

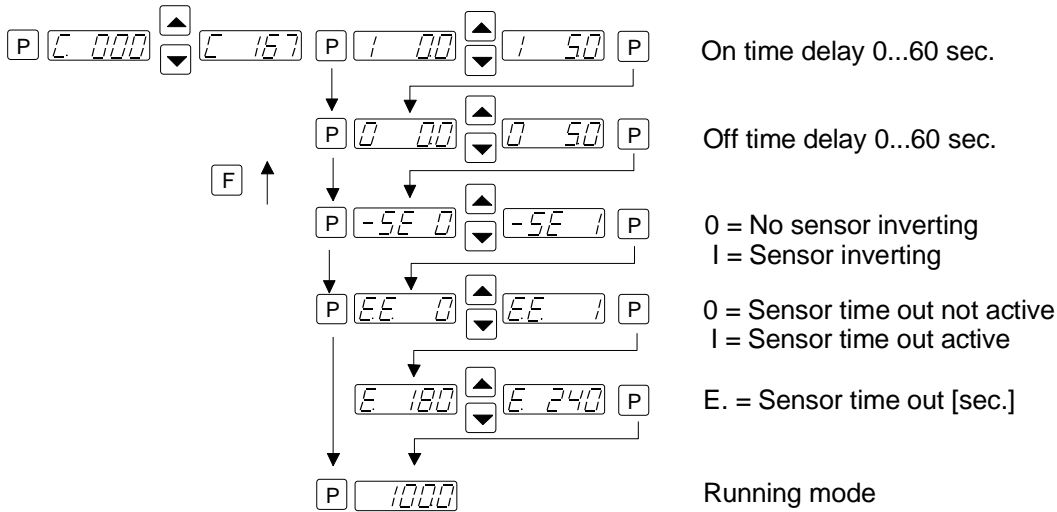

### 9.2.3 Sensor time out

Code C. 015

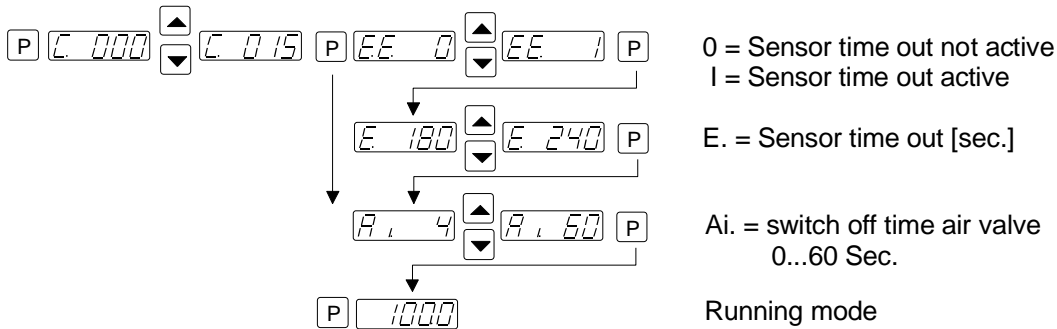

### 9.2.4 Set point source

Code C. 003

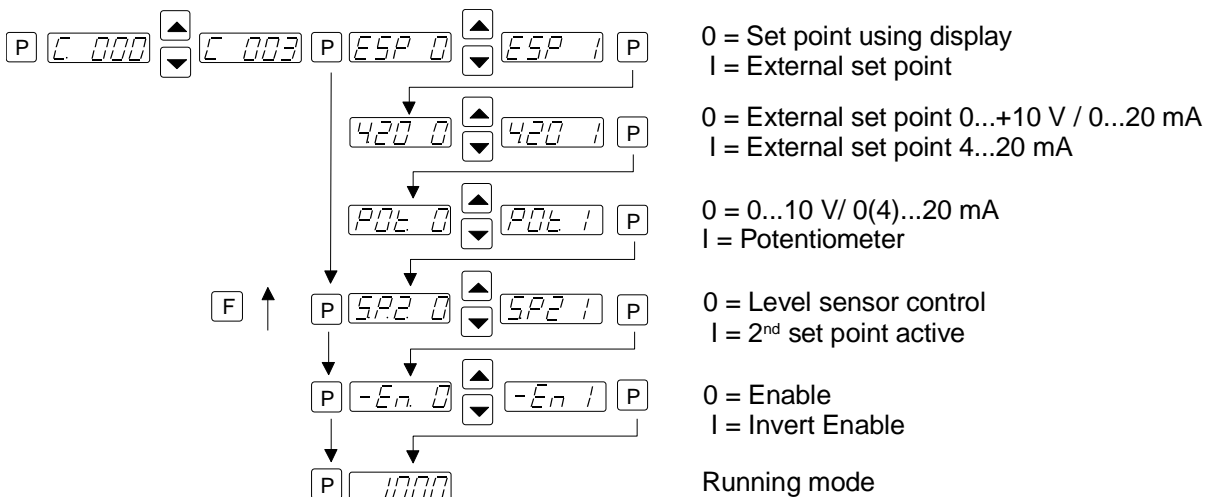

POT is not available on 16A IP20 units

### 9.2.5 Pulse feed

Code C. 004, 064

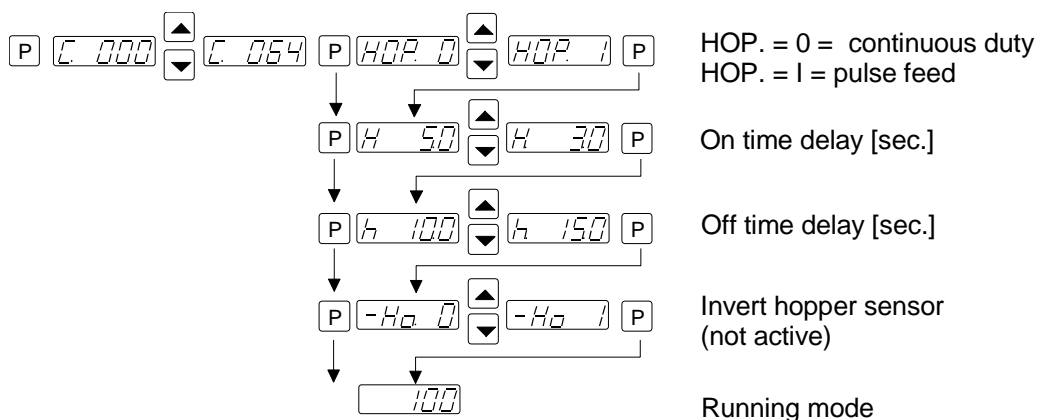

### 9.2.6 Regulation mode

Code C. 008

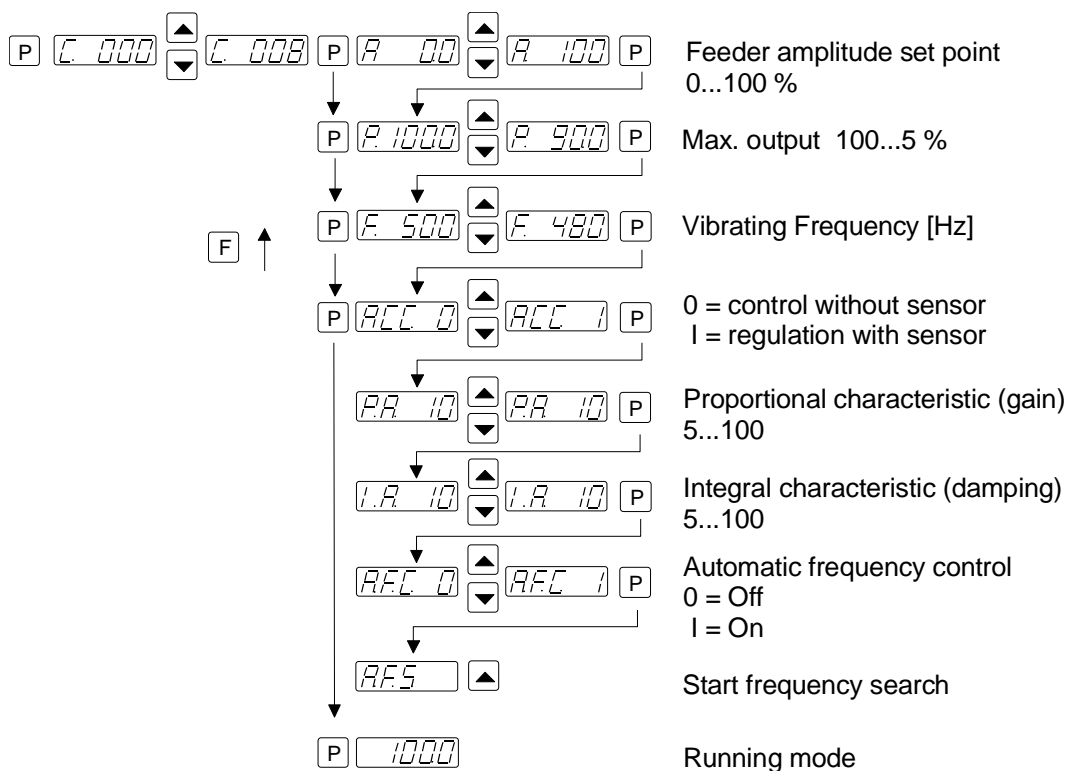

### 9.2.6.1 Instructions for using regulation mode

- An accelerometer e.g. SW 70 must be fitted to the vibratory feeder in order to run in regulation mode. The accelerometer should have a frequency range corresponding to that of the feeder.
- **All** vibration signals, that are picked up by the accelerometer, are used by the regulator circuit. Stray signals generated by neighbouring machinery, a flimsy accelerometer mounting, or an unstable support frame, can cause incorrect regulation to occur. It is especially important to ensure that there are no external influences, of this type, during the automatic frequency search routine.
- **Resonant frequencies:** It is possible to have several vibrating frequencies, where resonance occurs, depending on the springing and masses of the system. The additional resonant points are at multiples of the dominant resonant frequency. Under extreme circumstances the automatic frequency search may be unable to differentiate between these frequencies and so in these instances the frequency must be set manually.

### 9.2.6.2 Mounting the accelerometer

The accelerometer should generate signals for the movement and acceleration of the feeder, which are fed back to the regulator circuit of the control unit. Therefore it is very important that no other extraneous vibration signals are picked up by the sensor

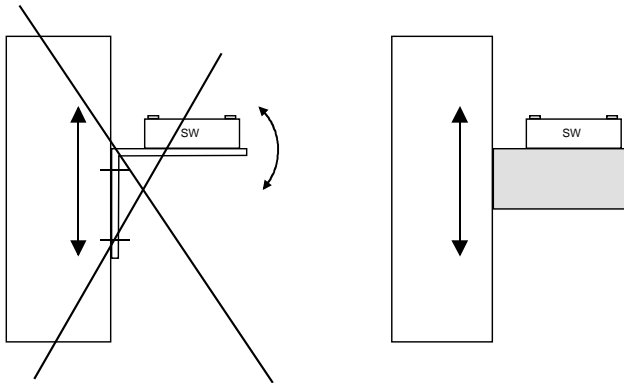

The sensor should be positioned, that it moves in the same direction as the feeder, ideally in the same plane as the springs. It should be fitted on a solid block that will not generate vibration signals.

**The sensor cable need to be fixed with a cable clamp to avoid damage of the cable.**

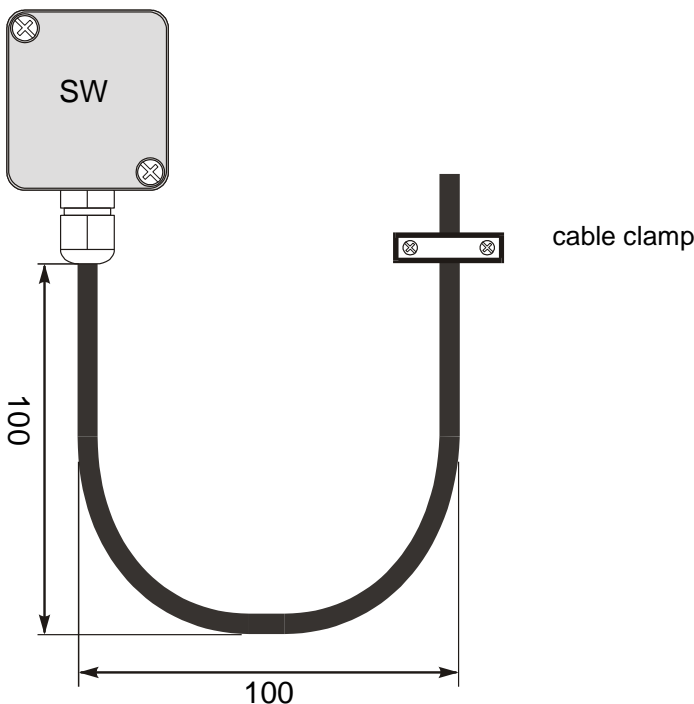



**In regulation mode the magnitude of the output signal has a direct effect on the maximum amplitude of the feeder.**

On bowl feeders it is advisable to fit the sensor as near as possible to the outside diameter and in this position it will be subjected to the greatest movement

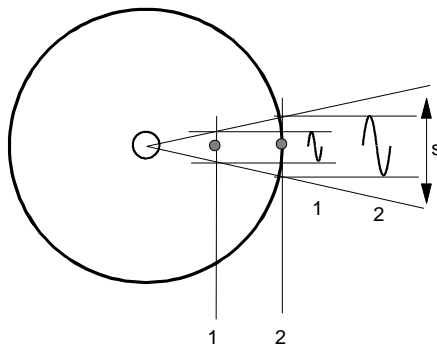

The control range of the set point will be considerably reduced when the sensor signal is weak.

s = deflection

Mounting position 1 = small deflection  
Mounting position 2 = large deflection

**Bowl feeder example**

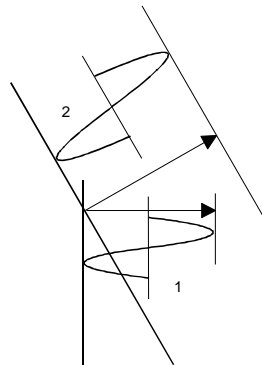
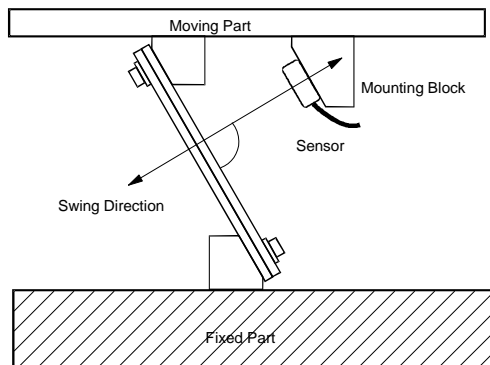

1. small amplitude because sensor is mounted vertically.

2. larger amplitude because sensor is mounted in the same plane as the springs.

**Linear feeder example**

The controller, together with the sensor fitted on the feeder, produce a feed back loop, whereby the signal generated from the sensor determines the control range of the set point i.e. the regulator controls the feeder so that the effective value (feeder power or intensity of vibration) relates to the provided set point value. Because the effective value is dependent on the feeder (frequency, acceleration and amplitude) and in addition depends on the mounting position of the sensor, the regulator must be adapted to suit the output control range.

This is achieved by using the parameter P in Menu C 008. The measured sensor signal range is adjusted by changing this value. In most instances a value of less than 100 must be entered, so that the set point can reach 100% or can go as high as possible.

When it is not possible to achieve an acceptable range the accelerometer should be mounted in the location which gives the greatest movement (see the bowl feeder example).

The importance of scaling this value is demonstrated when, for example, a feeder takes a very long time to ramp up, after it has been switched on.

### 9.2.6.3 Relationship between acceleration and amplitude

The sensor measures the momentary acceleration of the feeder. It generates a sinusoidal output voltage signal. The acceleration gets higher as the frequency increases. The sensor signal is greater for a higher frequency and lower amplitude than for a low frequency with a higher amplitude.

<p>Acceleration</p> $a = \omega^2 s \quad \text{where} \quad \omega = 2 \pi f$ <p>In practice the acceleration is influenced by gravitational force and the applied amplitude is measured in mm and so this gives the following formula:</p> $a[g] = \frac{2^2 \pi^2 f^2 [Hz]^2 s_n [mm]}{9,81 \cdot 2 \cdot 10^3} = \frac{f^2 [Hz]^2 s_n [mm]}{497}$ <p>a[g] = Acceleration ( with respect to gravitational acceleration of 9.81 m/s<sup>2</sup>) S<sub>n</sub>[mm] = Applied amplitude</p>	<p>In practice where 497 is approximated to 500 this gives, for example:</p> <p>1. Vibrating frequency 50Hz Amplitude 3mm</p> $a = \frac{50^2 \cdot 3}{\approx 500} = 15 g$ <p>Or 2. Vibrating frequency 33Hz Amplitude 5mm</p> $a = \frac{33^2 \cdot 5}{\approx 500} = 10,89 g$
--	--

Using an accelerometer with an output signal of 0.3 V/g the sensor generates a peak voltage of 4.5V for a peak acceleration of 15g (Example 1), corresponding to a 3.18V RMS value.

Example 1: => 15 g => 4,5 V => 3,18 V<sub>eff</sub>.

Example 2: => 11 g => 3,3 V => 2,33 V<sub>eff</sub>.

Because of the vastly different acceleration values of various feeders there is a big difference in the feed back signals, which makes scaling necessary.

### 9.2.6.4 Instructions for setting up the controller in regulation mode

Connect control unit

Install sensor and connect to controller

### 9.2.6.5 Determining the resonant frequency

#### Manual setting of the vibrating frequency

It is essential that the output frequency is adjusted with the set point set at a low frequency, otherwise on hitting the resonant frequency it is possible to achieve a high amplitude with a low output voltage. An analog, effective value, current indicating unit (moving iron meter) must be connected into the output circuit.

**Resonant frequency is reached when there is a maximum amplitude for a minimum output current.**

#### Automatic frequency search

- The feeder should be empty for a frequency search
- Adjust the set point to zero
- Select regulation mode (Menu C 008, Parameter ACC = 1 )
- The optimum frequency of the feeder is found, automatically, by initiating the frequency search (Menu C 008, Parameter A.F.S.). When this has been found the controller resets the set point back to its original value (0).

### 9.2.6.6 Optimising controller in regulation mode

#### Setting the control range

1. In Menu C. 096 set parameter P (Max Limit) to 50 %
2. Set A (Feeder throughput) to 100%
3. Increase limit P from 50% until the required maximum feeder throughput is achieved

The full set point adjustment range of 0...100% can now be used

#### Optimising regulation: For unwanted feeder oscillation (hunting) or inadequate feedback regulation for load changes

The response of the regulation circuit can be adjusted in menu C008 using the parameter PA (Proportional characteristic or circuit gain) and IA (Integral characteristic)

In menu C008 reduce PA until the oscillations are reduced

Parameter IA should be set to at 100 if possible

### 9.2.6.7 Displays



1. The maximum output power of the controller has been reached. The feedback signal from the sensor (acceleration) is too low in comparison with the set point. Reduce parameter P in Menu C096 or C008.
2. The maximum current setting has been reached.



**Peak value display**  
The feedback signal from the sensor (acceleration) is too high. Place the sensor at a location with a lower vibration range or use a sensor with a lower output signal.

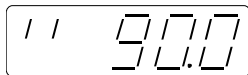

**Changing display:**  
The regulator oscillates too quickly. Reduce parameter PA in Menu C008.

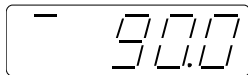

### 9.2.7 Display actual current and frequency

Code C. 040

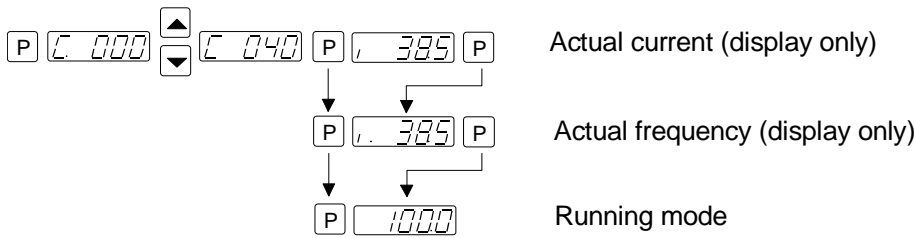

### 9.2.8 Save selected parameters

Code C. 143

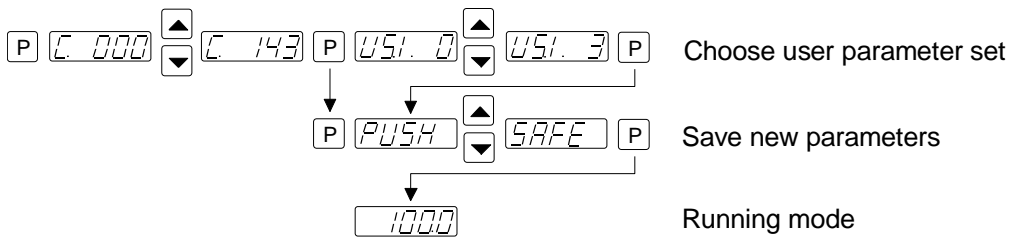

### 9.2.9 Recall user or factory settings

Code C. 210

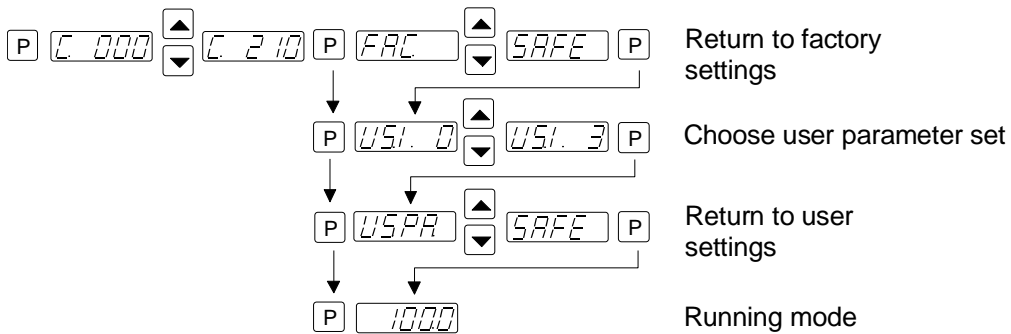

### 9.2.10 Hide parameter menus

Code C. 117

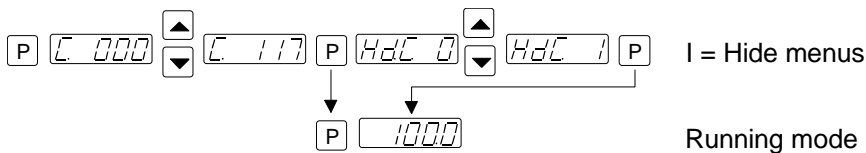

## 10.0 Error messages / ERROR reset

Errors are indicated by an alternating code and ERROR display

### Overload limit

Output level exceeded e.g. incorrect frequency setting, coil air-gap too wide.

Error OL

### Short circuit trip

Faulty coil, short circuit or defective cable.

Error SC

### Over voltage

Supply voltage too high or back EMF from the coil at lower frequencies.

Error OV

### Current spike limit

Frequency set too low for installed coil or frequency altered too rapidly during setting up.

Error PER

**Sensor fault** (only when regulation mode is selected)  
Accelerometer not working or faulty.

Error ACC

## ERROR Reset through Menu C009

### Sensor time out

After sensor time out has elapsed

Error SE

**ERROR Reset is achieved by pressing touch panel keys 0 or I during normal operation or by using Menu C009.**

In the event of an error check that this is not caused by incorrect wiring or cable faults. The error message, ERROR ACC, can also occur if regulation mode is chosen (in Menu C008) and an accelerometer is not connected, for example.

Reset the error in the following manner:

## ERROR RESET

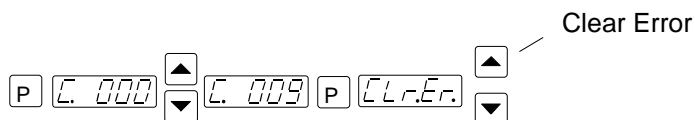

**Frequently appearing Errors, which are not described in this chapter, should be reported to the manufacturer.**

**11.0 Connections for enclosed construction (IP 54): 6-8 A Units**

Internal connections

When a potentiometer is connected parameter POT must be set to I in Menu C003.

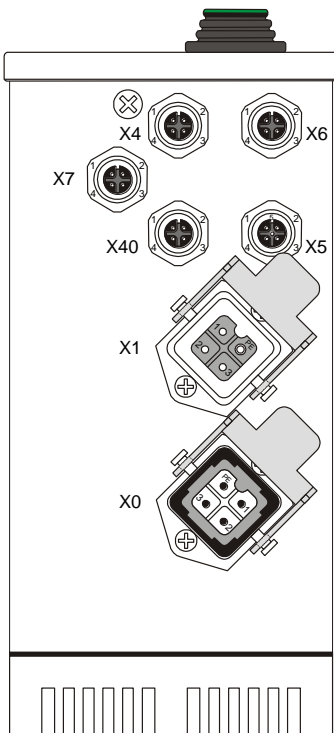
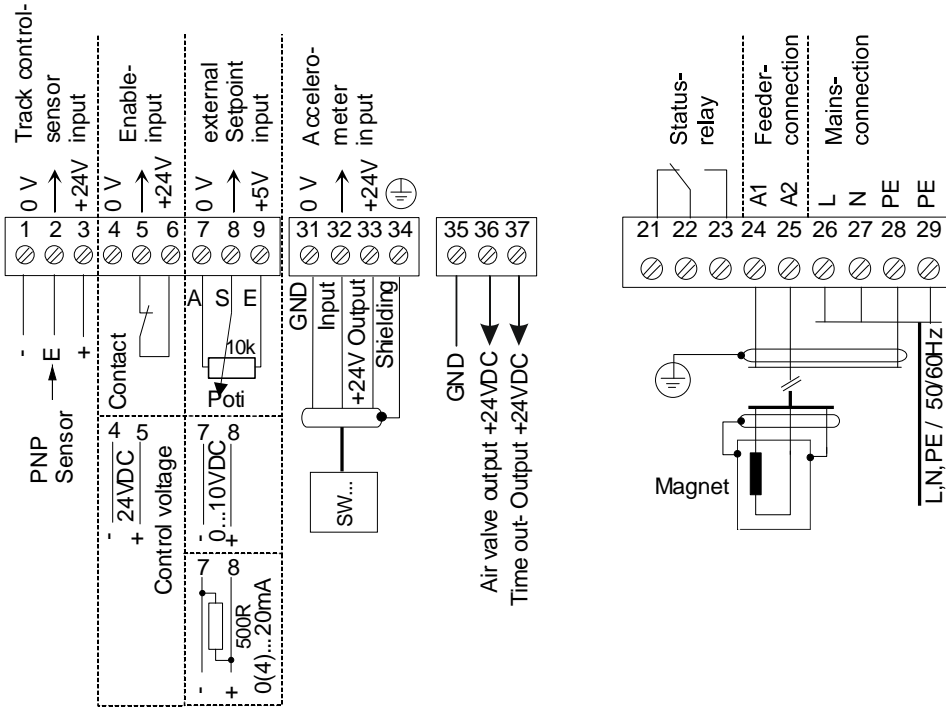

Sensor Track control (X4)

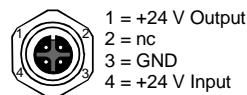

Acceleration sensor (X40)

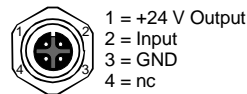

Enable input (X6)

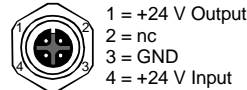

Status ON/OFF (X5)

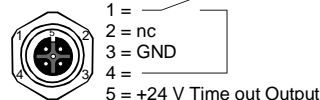

Output air valve (X7)

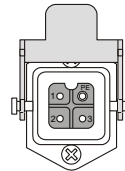
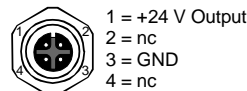

Output Feeder (X1)

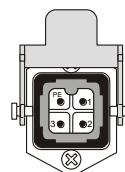
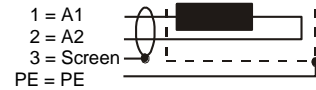

Input main supply (X0)



The output cable to the feeder must be screened to conform with EMC regulations.

11.1 Connections for enclosed construction (IP 54): 12 A Units

Internal connections

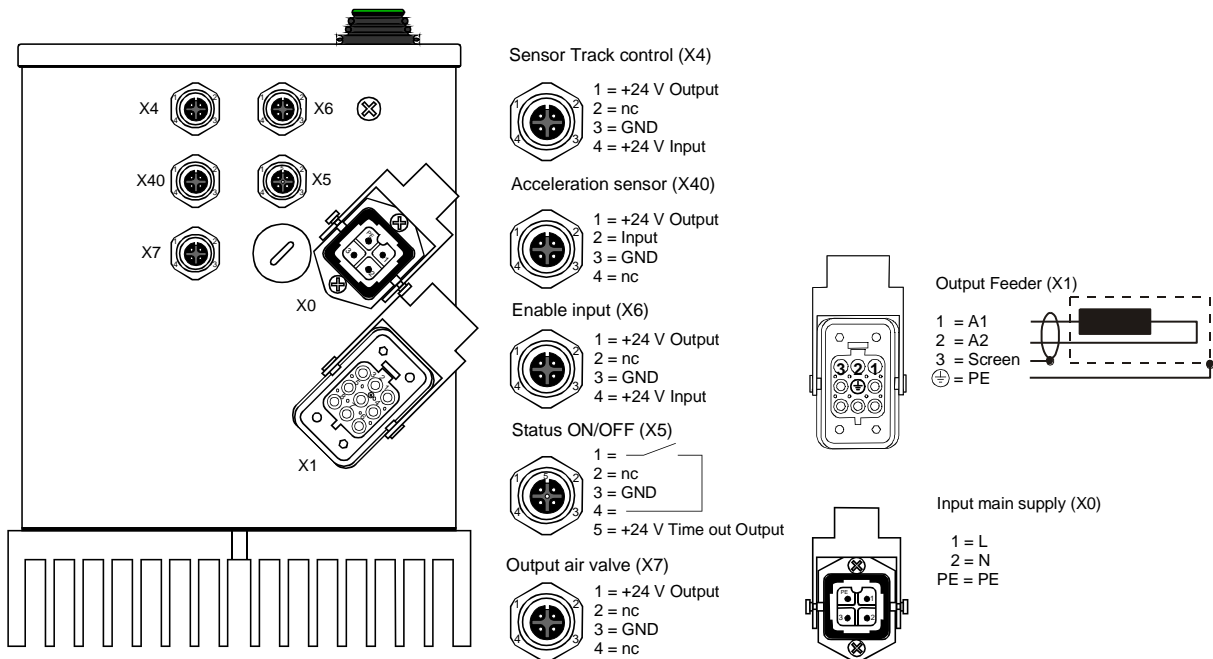
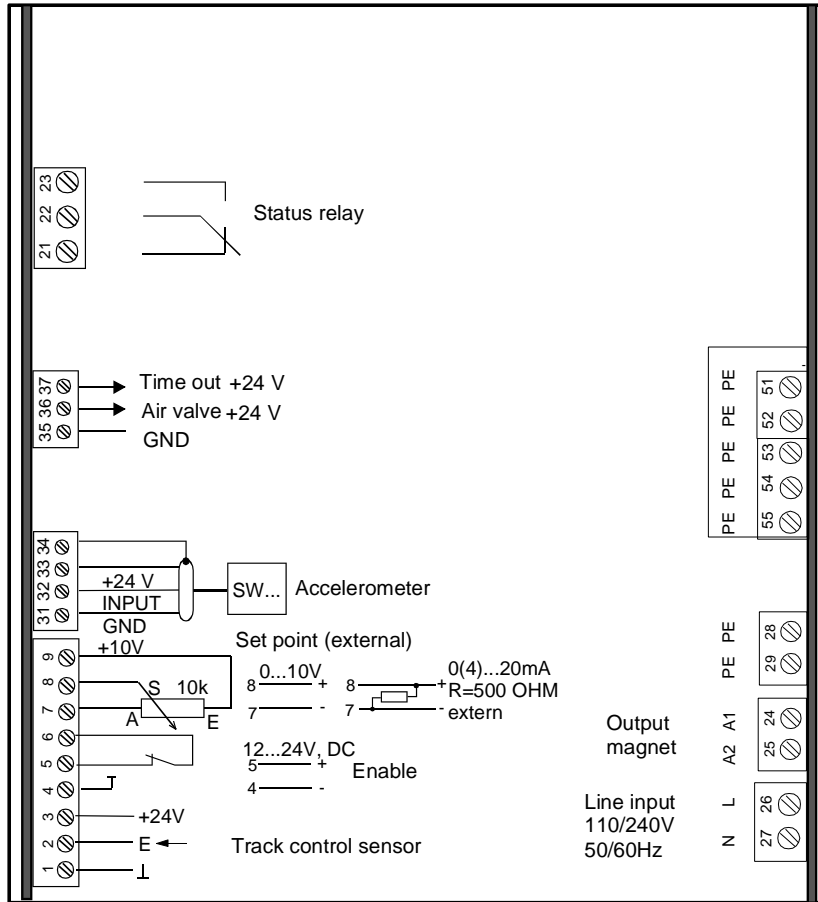

The output cable to the feeder must be screened to conform with EMC regulations.

11.2 Connections for enclosed construction (IP 54): 16 A Units

Internal connections

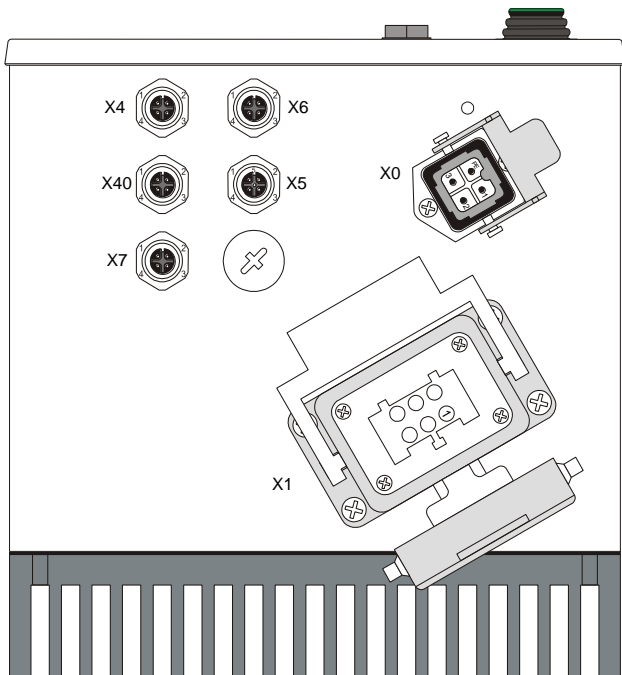
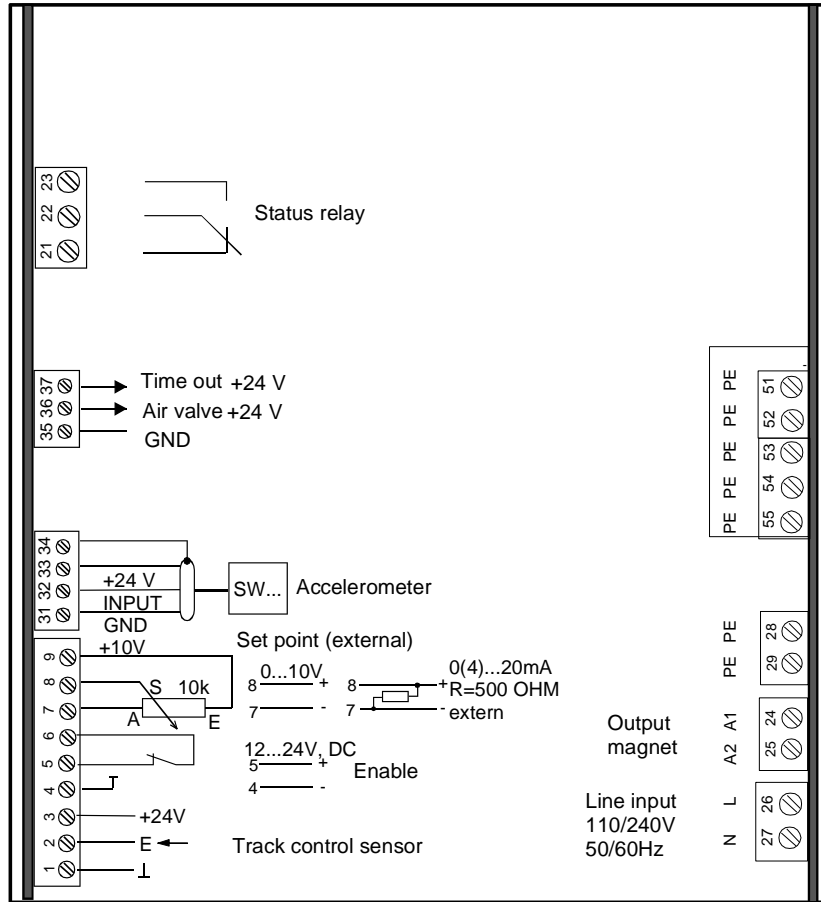

Sensor Track control (X4)

- 1 = +24 V Output
- 2 = nc
- 3 = GND
- 4 = +24 V Input

Acceleration sensor (X40)

- 1 = +24 V Output
- 2 = Input
- 3 = GND
- 4 = nc

Enable input (X6)

- 1 = +24 V Output
- 2 = nc
- 3 = GND
- 4 = +24 V Input

Status ON/OFF (X5)

- 1 =
- 2 = nc
- 3 = GND
- 4 =
- 5 = +24 V Time out Output

Output air valve (X7)

- 1 = +24 V Output
- 2 = nc
- 3 = GND
- 4 = nc

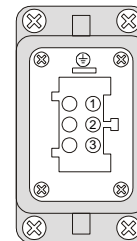

Output Feeder (X1)

- 1 = A1
- 2 = A2
- 3 = Screen
- ⊕ = PE

Input main supply (X0)

- 1 = L
- 2 = N
- PE = PE

The output cable to the feeder must be screened to conform with EMC regulations.



12.0 Connections for panel mounting construction (IP 20): 3 A, 6 A, 8 A

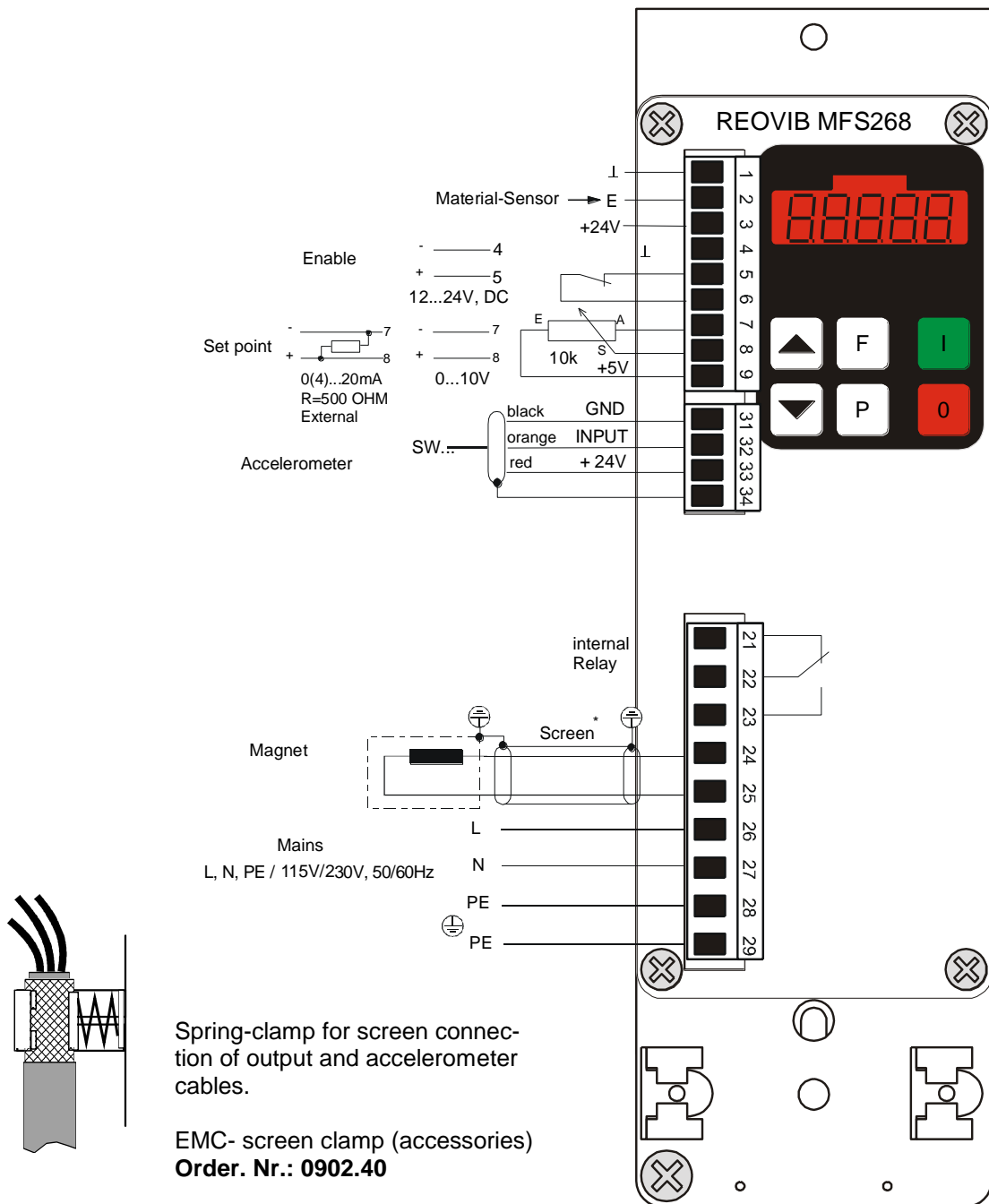

The output cable to the feeder must be screened to conform with EMC regulations.

**When a potentiometer is connected parameter POT must be set to I in Menu C003.**

12.1 Connections for panel mounting construction (IP 20): 16A

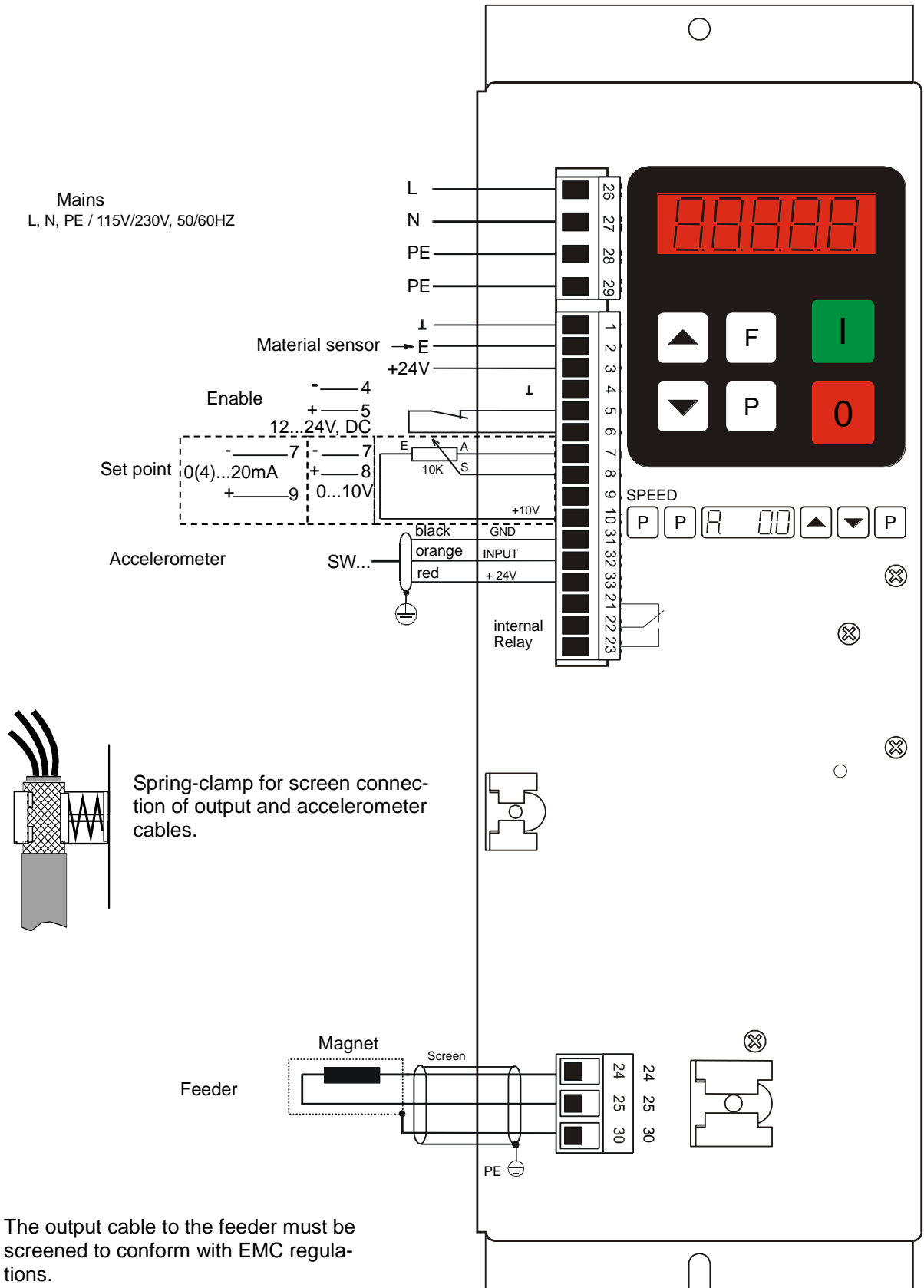

13.0 Dimensions for 3 A, 6 A, 8 A Units

Enclosed construction, (IP 54)

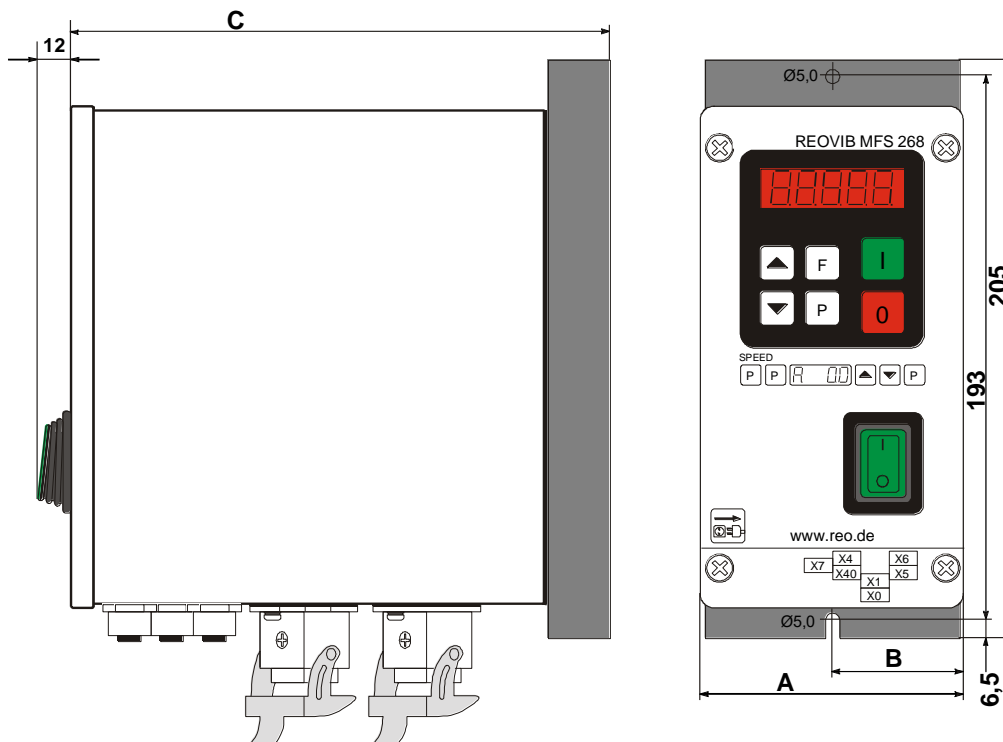

Panel mounting construction, (IP 20)

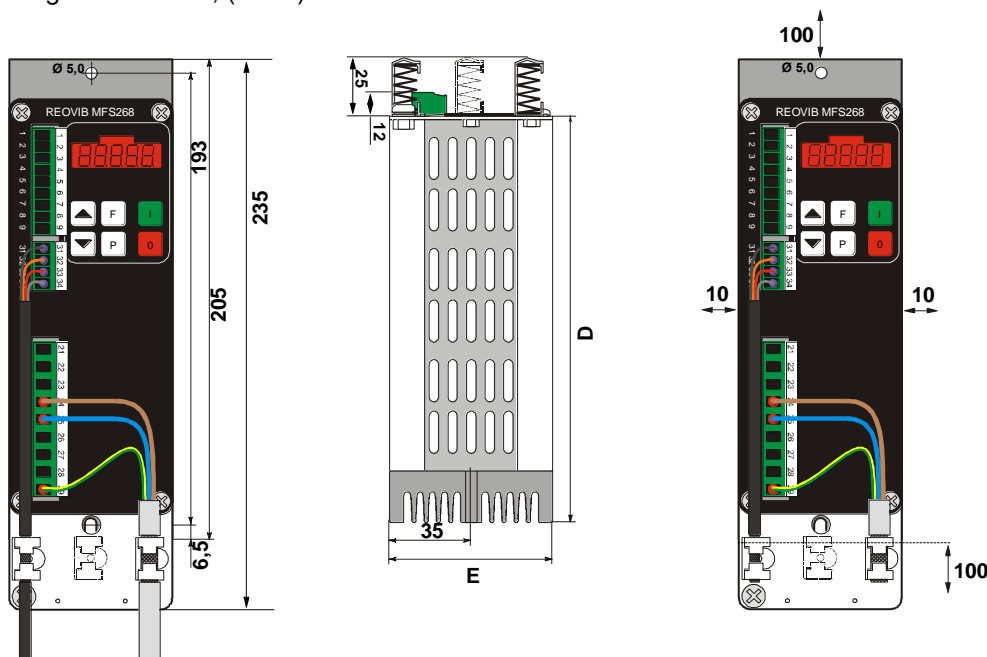

	3A	6A	8A
A	-	90	100
B	-	45	50
C	-	191	209
D	155	175	195
E	70	70	104

All dimensions in [mm]

**13.1 Dimensions of enclosed construction (IP 54) 12 A**

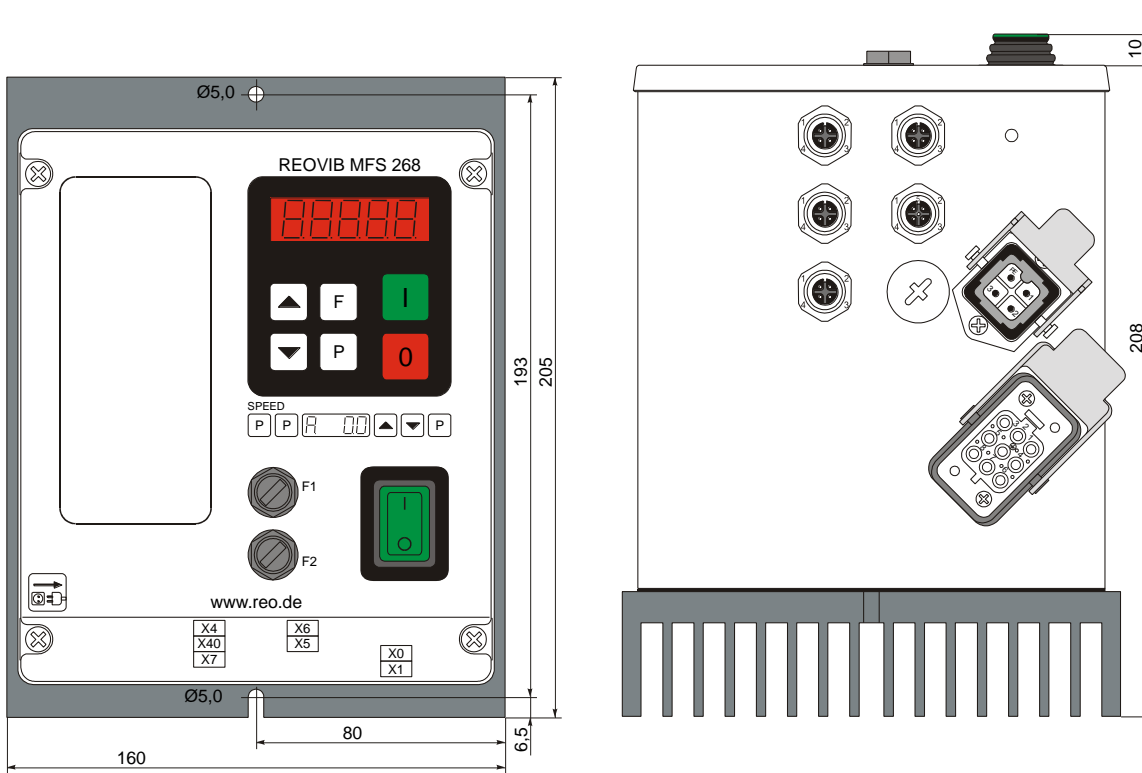

**13.2 Dimensions of enclosed construction (IP 54) 16 A**

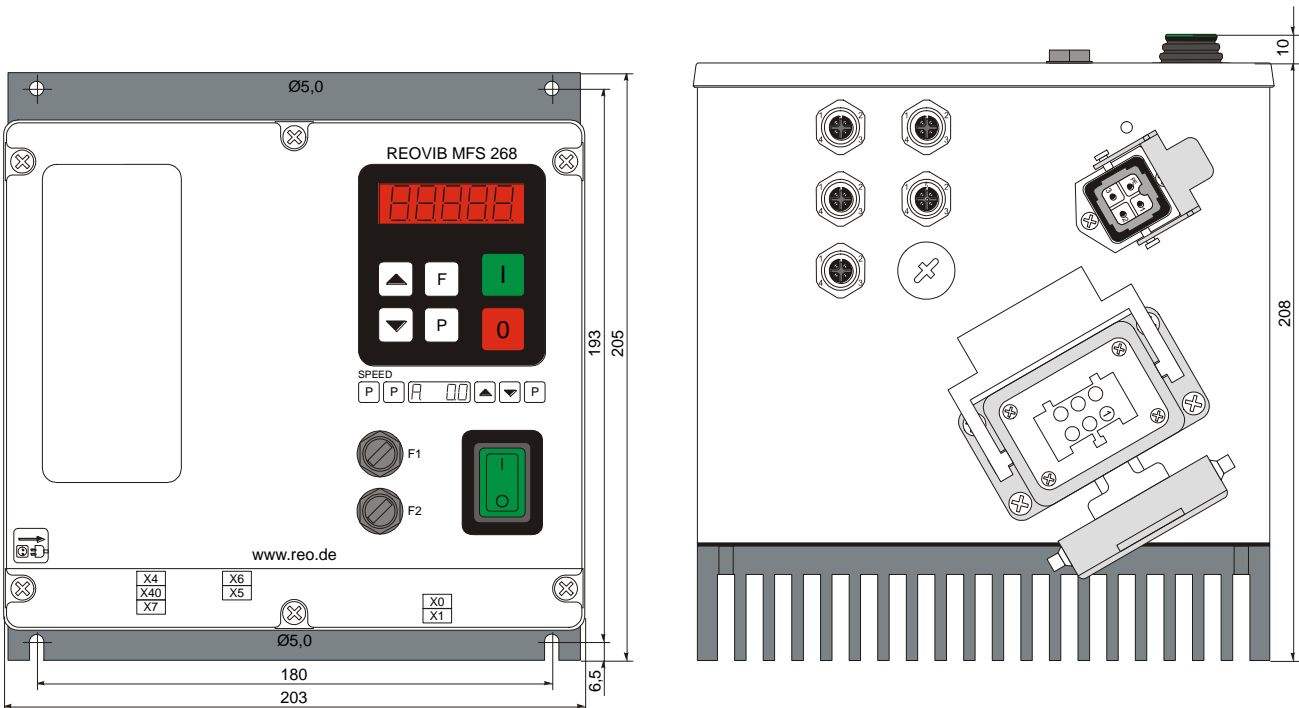

13.3 Dimensions of Panel mounting construction (IP 20) 16 A

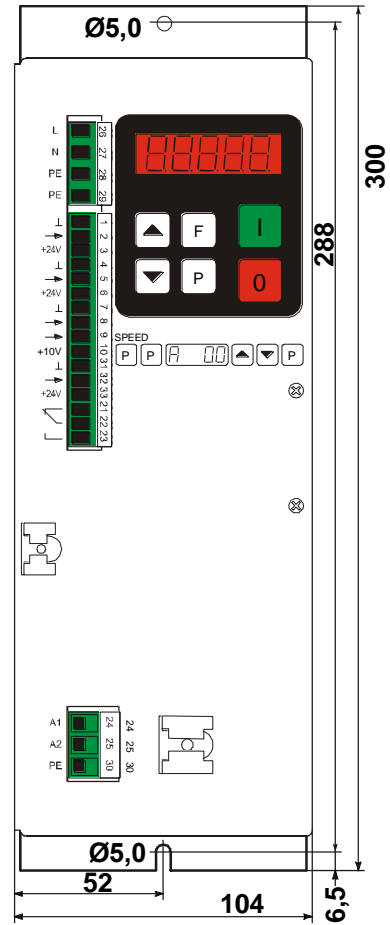
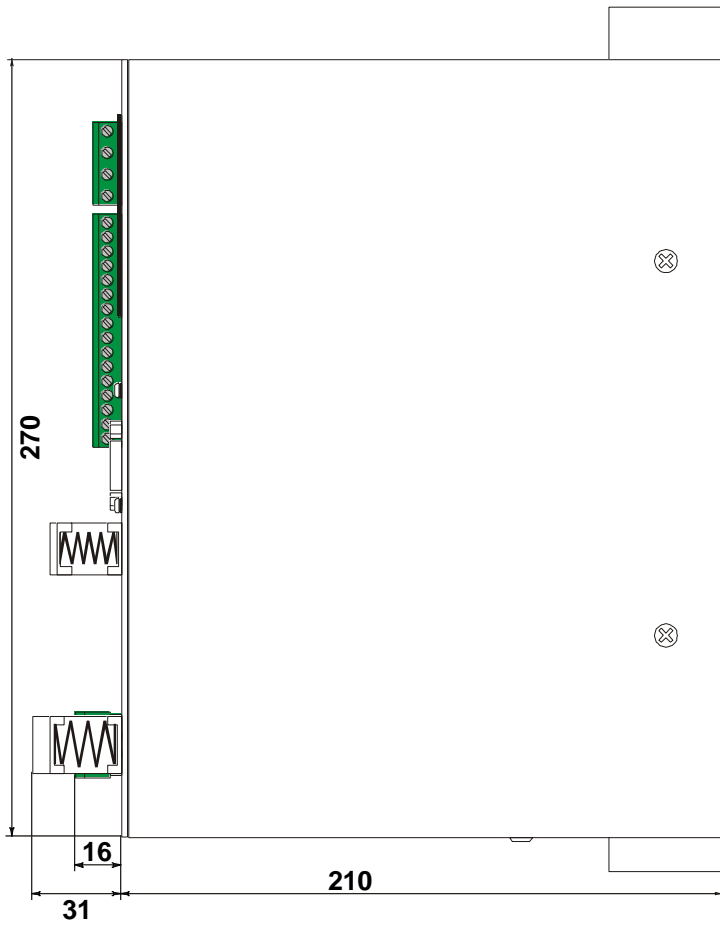

## A 1.0 Service appendix

### ATTENTION !

The settings described in this section relating to the service menu are intended for use by skilled persons because the functions and limits of the feed system can be greatly influenced by their adjustment

It is the responsibility of the supplier of the equipment to decide whether this information should be released or restricted for use by service engineers only.

The service menu cannot be accessed through the normal menu structure. It can only be enabled by using a special key code.

### Service Menu

The critical parameters, current limit and user adjustable frequency range are held in a separate service menu. This menu cannot be reached through the normal menu structure and must be enabled by using an additional code number. This prevents the unauthorised changing of these sensitive parameters

- **Current Limit** – Protects the coil against overload.  
The output current limit is set to the maximum current rating of the coil.
- **Frequency limits** – Protection against unhealthy operation.  
The vibrating frequency limits available to the user are fixed.
- **Output voltage limit 100 V**  
The output voltage limit allows 110v coils to be used on a 230V supply without damage.

Parameter:		Display	Factory setting:	Entry code:
• Enable service menu	0 / 1	En.S:	0	127
• Adjust current limit	0...100 %	I.	100	040
• Set lower frequency	5...300 Hz	F.L.	35	040
• Set upper frequency	6...300 Hz	F.H.	140	040
• Limit output voltage 100 V	0 / 1	P.Li.	0	040

## Frequency adjustment range

The control unit is supplied with a maximum frequency range of 5...150Hz. Using an adjustable under and over frequency limits, the user range (parameter F) can be restricted to a maximum ratio of 1:4. In regulation mode, this restricted frequency range has great importance because it assists with the accurate determination of the measurement signals from the accelerometer. During the automatic frequency search a maximum sweep range of 1:4 is possible. The lower (FL) and upper (FH) frequency limits restrict the range. A narrow setting of the limits of less than 1:4 is possible and also advisable because this ensures that widely different changes of the frequency cannot occur when the user is setting up the system.

**The range of the automatic frequency control (AFC) is also limited by these settings.**

**A practical setting is +/- 20 % of resonance.**

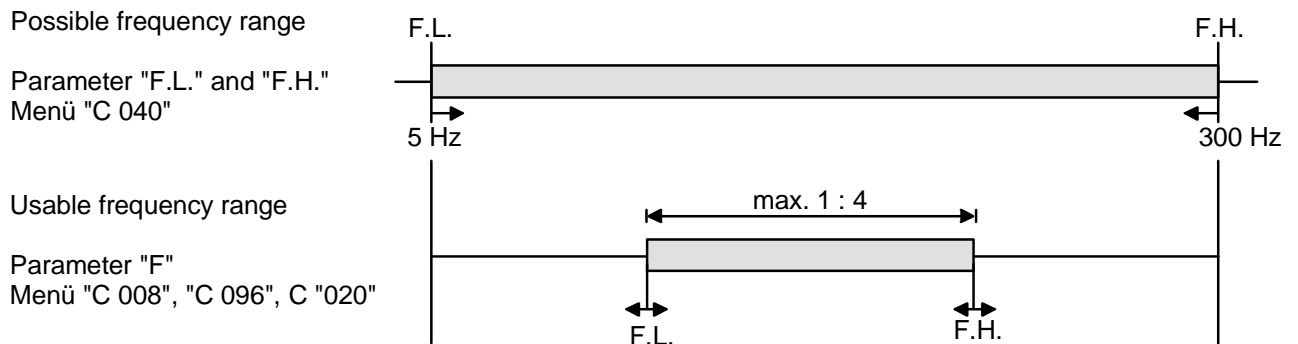

1. Set lower frequency limit.
2. Set upper frequency limit.

## Current limiting

The current limit is used to set the controller for the rated current of the coil  $I_M$ . The current limit  $I_{MAX}$  is set by using parameter I. The displayed setting is expressed as a percentage of the controllers rated current  $I_N$  (100 % corresponds to the units rated current).

$$I_{MAX} = \frac{I_M \cdot 100}{I_N}$$

To protect the coils the current limit must be set to the rated current for the coil(s)  $I_M$ .

When several coils are connected in parallel the coil current is the sum of all individual currents.

### Enable Service Mode

The actual service menu is accessed by opening the service mode.

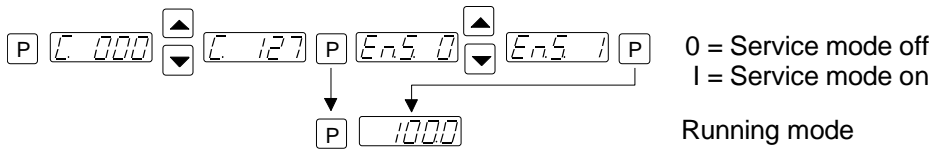

The normal service menu, containing the output current and frequency limit settings, is accessed by opening the service mode.

### Service menu

Code 040

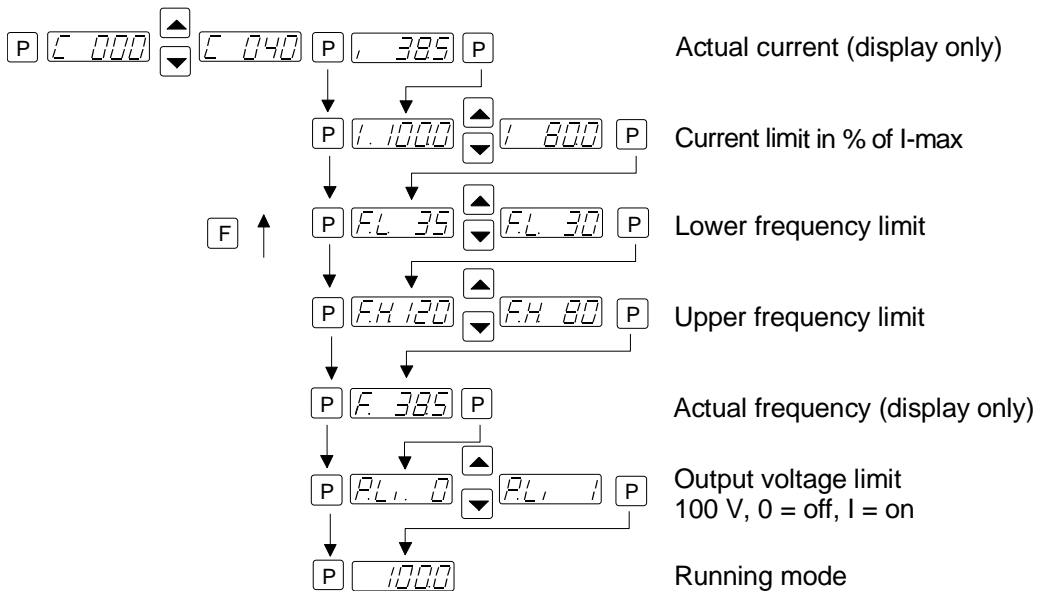

**After making adjustments the service mode must be closed again!**



**A 2.0 Accessories / Spare Parts**

Type:	Accessories / Spare Parts:	Reo Order Number:	Manufacturer Order Number:
<b>MFS 6A-8A IP 54</b>	mains input coupling (HAN 3A-BU-S)	90218	Harting: 09 20 003 2711 + 19 20 003 1440 + 19 00 000 5082 + 09 20 000 9918
	output connector (HAN 3A-STI)	90212	Harting: 09 20 003 2611 + 19 20 003 1440 + 19 62 000 5082 + 09 20 000 9918
	M12-Connector 4-pin	90131	Lumberg Automation: 11584
	M12-Connector 5-pin	90132	Lumberg Automation: 11590
	1x input fuse 6,3A	28400060000	Mersen: MI5SU25V6.3
	Accelerometer	e.g.: 45770 (300mV/g)	
<b>MFS 12A IP 54</b>	mains input coupling (HAN 3A-BU-S)	90218	Harting: 09 20 003 2711 + 19 20 003 1440 + 19 00 000 5082 + 09 20 000 9918
	output connector (Han Q8/0-M-QL)	90242	Harting: 09 12 008 2633 + 19 12 008 0501 + 19 62 000 5057
	M12-Connector 4-pin	90131	Lumberg Automation: 11584
	M12-Connector 5-pin	90132	Lumberg Automation: 11590
	2x input fuse 10A	28400392300	Mersen: MI5SU25V10
	Accelerometer	e.g.: 45770 (300mV/g)	
<b>MFS 16A IP 54</b>	mains input coupling (HAN 3A-BU-S)	90218	Harting: 09 20 003 2711 + 19 20 003 1440 + 19 00 000 5082 + 09 20 000 9918
	output connector (Han 6E-bu-s)	90238	Harting: 09 33 006 2701 + 19 30 006 1440 + 19 62 000 5082
	M12-Connector 4-pin	90131	Lumberg Automation: 11584
	M12-Connector 5-pin	90132	Lumberg Automation: 11590
	2x input fuse 10A	28400392300	Mersen: MI5SU25V10
	Accelerometer	e.g.: 45770 (300mV/g)	
<b>MFS 3A-8A IP 20</b>	EMC- screen clamp: 3-8	90240	Weidmüller: 1692261001
	1x input fuse	28400060000	Mersen: MI5SU25V6.3
	Accelerometer	e.g.: 45710 (300mV/g)	
<b>MFS 16A IP 20</b>	2x input fuse 10A	28400392300	Mersen: MI5SU25V10
	Accelerometer	e.g.: 45710 (300mV/g)	







## ■ REO AG

Brühler Straße 100 · D-42657 Solingen  
Tel.: +49 (0)212 8804 0 · Fax: +49 (0)212 8804 188

E-Mail: [info@reo.de](mailto:info@reo.de)  
Internet: [www.reo.de](http://www.reo.de)

### Divisions:

#### REO Vibratory Feeding and Power Electronics Division

REO Vibratory Feeding and Power Electronics Division  
Brühler Straße 100 · D-42657 Solingen  
Tel.: +49 (0)212 8804 0 · Fax: +49 (0)212 8804 188  
E-Mail: [info@reo.de](mailto:info@reo.de)

#### REO Train Technologies Division

REO Train Technologies Division  
Erasmusstraße 14 · D-10553 Berlin  
Tel.: +49 (0)30 3670236 0 · Fax: +49 (0)30 3670236 10  
E-Mail: [zentrale.berlin@reo.de](mailto:zentrale.berlin@reo.de)

#### REO Drives Division

REO Drives Division  
Holzhausener Straße 52  
D-16866 Kyritz  
Tel.: +49 (0)33971 485 0 · Fax: +49 (0)33971 485 90  
E-Mail: [zentrale.kyritz@reo.de](mailto:zentrale.kyritz@reo.de)

#### REO Medical and Current Transformer Division

REO Medical and Current Transformer Division  
Schuldhölzinger Weg 7 · D-84347 Pfarrkirchen  
Tel.: +49 (0)8561 9886 0 · Fax: +49 (0)8561 9886 40  
E-Mail: [zentrale.pfarrkirchen@reo.de](mailto:zentrale.pfarrkirchen@reo.de)

#### REO Test and PowerQuality Division

REO Test and PowerQuality Division  
Brühler Straße 100 · D-42657 Solingen  
Tel.: +49 (0)212 8804 0 · Fax: +49 (0)212 8804 188  
E-Mail: [info@reo.de](mailto:info@reo.de)

### PRODUCTION+SALES:

#### ■ China

REO Shanghai Inductive Components Co., Ltd  
E-Mail: [info@reo.cn](mailto:info@reo.cn) · Internet: [www.reo.cn](http://www.reo.cn)

#### ■ India

REO GPD INDUCTIVE COMPONENTS PVT. LTD  
E-Mail: [info@reogpd.com](mailto:info@reogpd.com) · Internet: [www.reo-ag.in](http://www.reo-ag.in)

#### ■ USA

REO-USA, Inc.  
E-Mail: [info@reo-usa.com](mailto:info@reo-usa.com) · Internet: [www.reo-usa.com](http://www.reo-usa.com)

### SALES:

#### ■ France

REO VARIAC S.A.R.L.  
E-Mail: [reovariac@reo.fr](mailto:reovariac@reo.fr) · Internet: [www.reo.fr](http://www.reo.fr)

#### ■ Great Britain

REO (UK) Ltd.  
E-Mail: [main@reo.co.uk](mailto:main@reo.co.uk) · Internet: [www.reo.co.uk](http://www.reo.co.uk)

#### ■ Italy

REO ITALIA S.r.l.  
E-Mail: [info@reotalia.it](mailto:info@reotalia.it) · Internet: [www.reotalia.it](http://www.reotalia.it)

#### ■ Poland

REO CROMA Sp.zo.o  
E-Mail: [croma@croma.com.pl](mailto:croma@croma.com.pl) · Internet: [www.croma.com.pl](http://www.croma.com.pl)

#### ■ Spain

REO ESPAÑA 2002 S.A.  
E-Mail: [info@reospain.com](mailto:info@reospain.com) · Internet: [www.reospain.com](http://www.reospain.com)

#### ■ Switzerland

REO ELEKTRONIK AG  
E-Mail: [info@reo.ch](mailto:info@reo.ch) · Internet: [www.reo.ch](http://www.reo.ch)

#### ■ Turkey

REOTURKEY ELEKTRONİK San. ve Tic. Ltd. Şti.  
E-Mail: [info@reo-turkey.com](mailto:info@reo-turkey.com) · Internet: [www.reo-turkey.com](http://www.reo-turkey.com)