

# Vibrating solenoids

## Manual for the use of vibrating solenoids

Whoever stops becoming better has  
stopped being good.

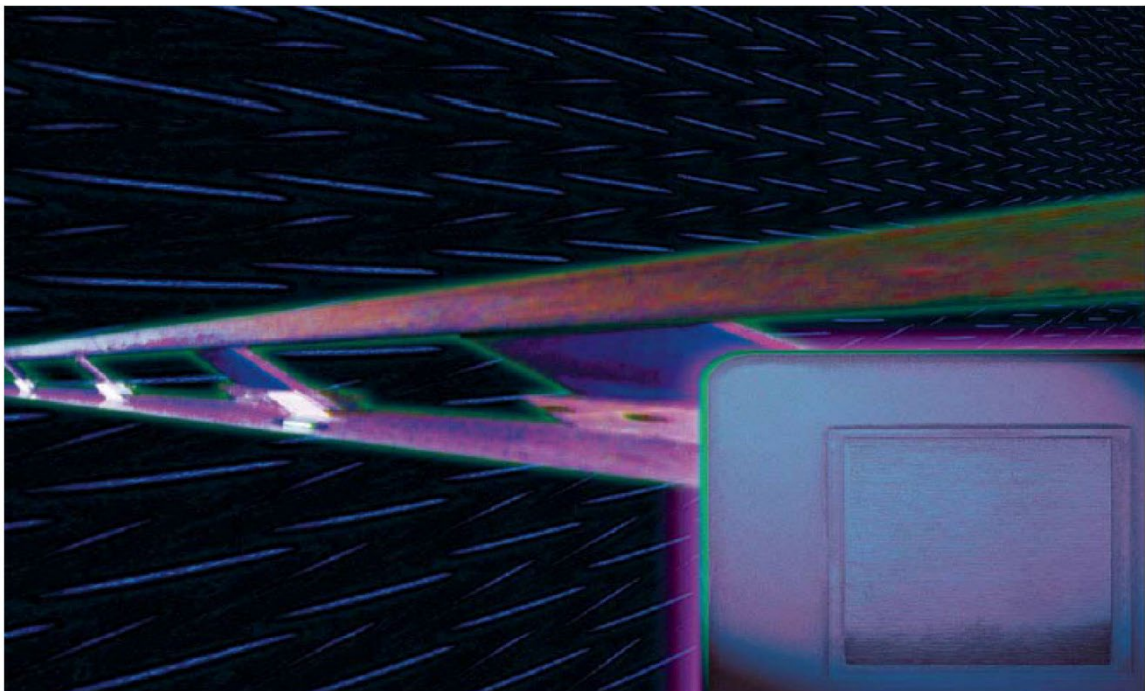

## Manual for the use of vibrating solenoids

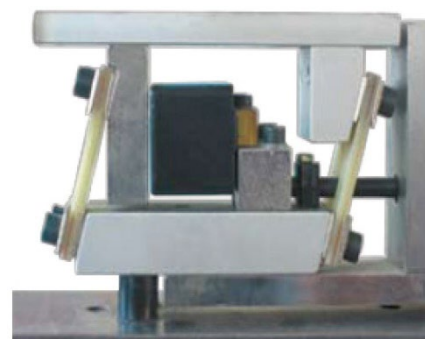

### Table of contents

	Page
1.0 General	3
1.1 Definition (as per DIN VDE 0580)	3
1.2 Construction concept	4
2.0 Construction and design	4
2.1 Construction	4
2.2 Design	4
3.0 Force and air gap	5
3.1 Force	5
3.1.1 Connection via half-wave rectifier	5
3.1.2 Direct connection	5
3.1.3 Connection via thyristor control system	6
3.1.4 Peak traction	6
3.2 Air gap	6
3.2.1 Rated air gap	6
3.2.2 Vibration amplitude for vibrating solenoids and magnetic vibrators	6
4.0 Voltage, current, power, frequency and protection class	6
4.1 Voltage	6
4.1.1 Rated voltage	6
4.1.2 The continuous permissible voltage change	6
4.1.3 Protective conductor connection	6
4.1.4 Test voltages	7
4.2 Current	7
4.3 Performance	7
4.4 Frequency	8
5.0 Operating time, temperatures, thermal class	8
5.1 Operating time	8
5.2 Temperature:	8
5.3 Thermal class	9
6.0 IBK vibrating solenoid connection	9
6.1 Direct mains connection	9
6.2 Connection via half-wave rectifier	10
6.3 Thyristor and/or frequency converter control system	10
7.0 IBK vibrating solenoid - series	11
7.1 Series WI standard	11
7.2 Series WI flat design	11
7.3 Series WI with changeover	11
7.4 Series WI for low frequencies	12
7.5 Series WI with corrosion protection	12
7.6 Series WE standard	13
7.7 Series WE with changeover	13
7.8 Series WI with changeover	13
8.0 Options for connecting vibrating solenoids to REOVIB control systems	13-14
Global-Player	15-17

## 1.0 General

Vibrating solenoids are electromagnetic devices that move periodically during excitation with alternating voltage. The vibration frequency is proportional to the mains frequency of the applied alternating voltage.

The IBK vibrating solenoid forms an electromagnetic vibrator in combination with masses and springs. The masses are therefore made to vibrate by the periodic movement.

REO INDUCTIVE COMPONENTS AG manufactures vibrating solenoids for handling technology, which are suitable for linear and round conveyors, for sifting, conveyor technology, packing. The supply programme includes solenoids for full-wave and half-wave operation, and special solenoids that are operated with a frequency control of 8 Hz.

The solenoid system is fully moulded and is optimal for use in the packaging and weighing industry, and in any automation technology where drives with vibrating systems are used.

IBK also manufactures special designs that are specially customised to meet customers' needs.

The system is controlled by means of an electronic phase angle (e.g. REOVIB MTS) or frequency regulation (e.g. REOVIB MFS), which enables optimal vibration technique in coordination with the solenoid.

These vibrating solenoids are characterised by low power consumption and optimal active power with low maintenance.

The vibrating solenoid is practically friction-free in the electromagnetic vibrator during work and makes little noise, and has subsequently become widespread in recent years as an important drive element in vibrating conveyor technology.



The VDE 0580 general specifications for electromagnetic devices and components apply to IBK vibrating solenoids.

### 1.1 Definition (as per DIN VDE 0580)

"Vibrating solenoid, magnet vibrator"

"A vibrating solenoid is an actuation magnet for which a periodic, back-and-forth movement is triggered by the effect of a magnetic field generated by excitation winding, in a spring and mass system with a vibration frequency that is generally in a fixed ratio to the frequency of the applied voltage."

GERMAN STANDARD

	<b>DIN VDE 0580 (VDE 0500)</b>	
	This standard is also a <b>VDE specification</b> in keeping with VDE 002. It was included in the VDE (German Electrical Engineering, Electronics and Information Technology Association) body of requirements under the aforementioned number, after the implementation of the authorisation procedure finalised by the VDE Executive Committee, and disclosed in "etz Electrical Engineering + Automation" (a German electrical engineering and automation technology specialist journal).	

## 1.2 Construction concept

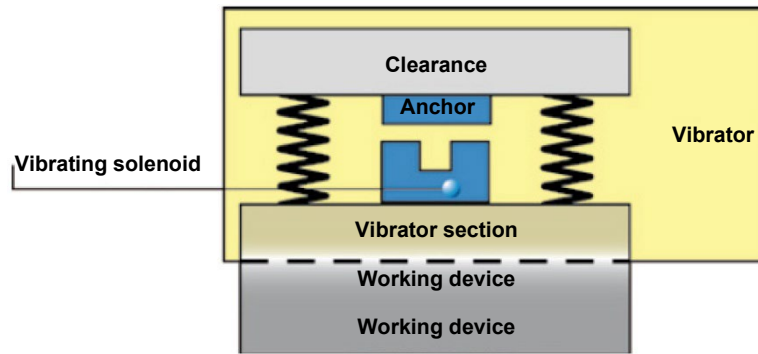

## 2.0 Construction and design

### 2.1 Construction

Vibrating solenoids are designed at IBK with UI or EI lamination. The vibrating solenoid is constructed very flat, in order for the vibrator measurements to remain low when the active material is fully utilised. Vibrating solenoids are supplied for direct connection and connection via half-wave rectifiers to the alternating voltage supply, and specially for certain REOVIB controllers.

Vibrating solenoids are manufactured in a potted design.

Type designation:        WI lamination UI  
                                 WE lamination EI

Colour designation:     potting in brown  
                                 for direct connection to the alternating voltage supply,  
                                 i.e. 6000 vibrations/min

                                 Potting in grey  
                                 for direct connection via half-wave rectifier to the alternating voltage supply,  
                                 i.e. 3000 vibrations/min

### 2.2 Design

IBK vibrating solenoids mainly consist of a magnetic body (yoke) and an anchor.

The magnetic body consists of U- and E-shaped high-quality magnetic sheets which are merged into a stable sheet stack. The sheet stack is mainly welded, but also screwed or riveted as well. This serves to meet the needs of the IBK vibrating solenoid, which increase with high frequencies. The excitation winding is mounted on the other two lines of the U-cores and/or the middle lines of the E-cores. The vibrating solenoid can be fastened in different ways. As a standard, the different types are fastened as follows:

**Type WI 111**     via round and/or long holes in the solenoid and anchor or  
                         via welded base plate on the solenoid

**Type WI 121**     via corresponding threaded holes with elastic wire thread inserts in the solenoid and anchor

**Type WE 131**     via welded base plate on the solenoid and a hole in the anchor

**Type WE 221**     via welded side angle on the solenoid and a hole in the anchor

All vibrating solenoids are provided with flexible connections with ample cross-sectional dimensions. The electrical connection is created via a cable with or without a protective conductor and/or via strands.

The anchor is usually the part of the solenoid that is pulled into the rhythm of the vibration frequency. Its mechanical structure is similar to that of the magnetic body.

The surfaces of the iron parts are slightly greased to avoid corrosion, and can be protected with a galvanic coating when used in a damp environment or in the food industry.

### 3.0 Force and air gap

For IBK vibrating solenoids, the force pulsates at twice the frequency of the alternating voltage, from zero value to peak value.

#### 3.1 Force

##### 3.1.1 Connection via half-wave rectifier

When the IBK vibrating solenoid is connected via a half-wave rectifier, the force then pulsates at the mains frequency.

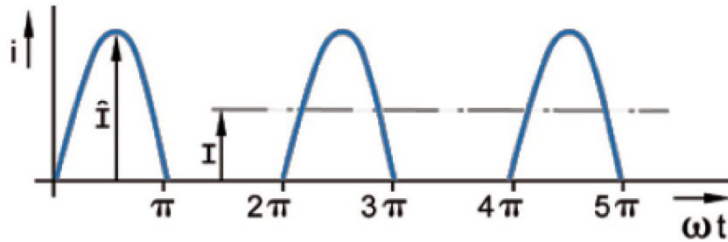

Current/time diagram

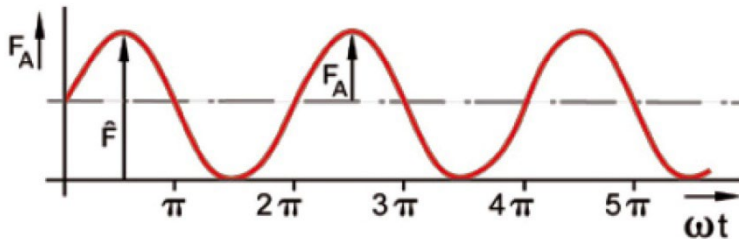

Force/time diagram

$\hat{i}$  = peak current  
 $I$  = effective current  
 $\hat{F}$  = peak traction  
 $F_A$  = amplitude force

##### 3.1.2 Direct connection

When connected to the mains with a direct alternating voltage, the force then pulsates at twice the mains frequency.

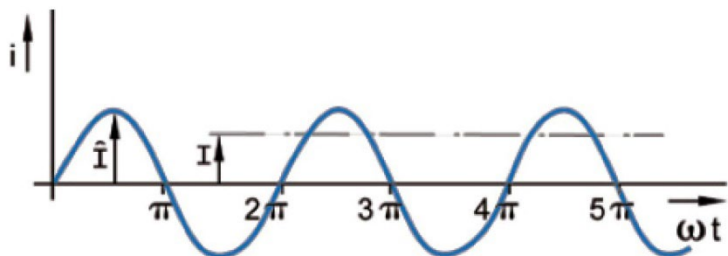

Current/time diagram

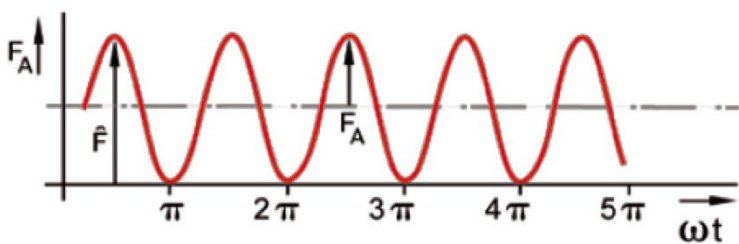

Force/time diagram

$\hat{i}$  = peak current  
 $I$  = effective current  
 $\hat{F}$  = peak traction  
 $F_A$  = amplitude force

### 3.1.3 Connection via thyristor control system

The majority of control devices work with thyristors and/or TRIACs in phase angle control. The conveyor power of the vibrating conveyor can be continuously adjusted in this way, but the vibration frequency of the conveyor is rigidly coupled to the mains frequency of the supplying mains. Depending on the drive, the conveyor can vibrate at the same frequency as the mains (e.g. 50 Hz) when controlled by only one sine half-wave, or at twice the frequency (e.g. 100 Hz) when controlled by both sine half-waves.

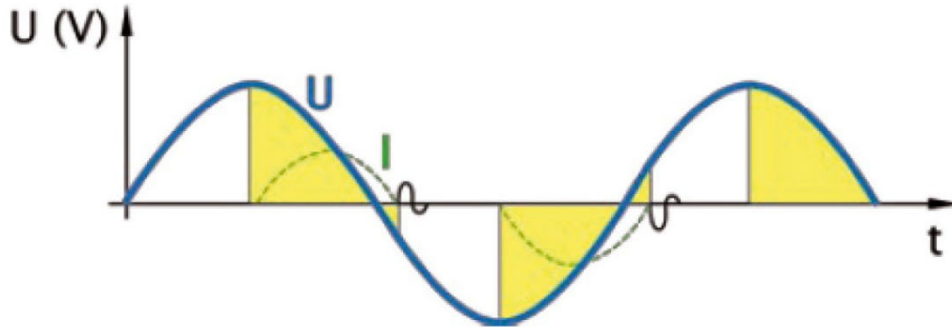

### 3.1.4 Peak traction

The peak traction is the magnetic force listed in the table, and therefore the largest force developed by the solenoid. It is measured with a rated air gap in a static calculation (resting solenoid). The values provided are related to the operating temperature of the solenoid and 95% rated voltage.

Peak traction  $F$  is the force that is measured with an equivalent direct current, which is equal to the peak value of the unidirectional current and/or alternating current (see VDE 0580).

## 3.2 Air gap

### 3.2.1 Rated air gap

is the air gap provided on the information sheet.

### 3.2.2 Vibration amplitude for vibrating solenoids and magnetic vibrators

The vibration amplitude for vibrating solenoids and magnetic vibrators is the sum of the vibration range of the working mass and the clearance (see construction concept). Half of the permitted vibration amplitude is less than the rated air gap between the anchor and vibrating solenoid when not excited.

## 4.0 Voltage, current, power, frequency and protection class

### 4.1 Voltage

Voltage and current information are essentially effective values for IBK vibrating solenoids. These effective value terms apply to both half-wave rectifier and frequency control operation, and direct alternating voltage mains connections.

#### 4.1.1 Rated voltage

The rated voltage stated on the type plate of an IBK vibrating solenoid is the voltage of the supplying alternating current mains or the control system to which the IBK vibrating solenoid is connected. The preferred voltages for IBK vibrating solenoids are 110, 200 and 230 V.

#### 4.1.2 The continuous permissible voltage change

for vibrating solenoids, at the terminals of the solenoid when switched on, is  $\pm 5\%$ .

#### 4.1.3 Protective conductor connection

The protective conductor connection is labelled with the "protective conductor" diagram (DIN 30600, reg. no. 1545).

#### 4.1.4 Test voltages

All IBK vibrating solenoids are checked for dielectric resistance before leaving the factory, as proof of their insulation capacity.

For electromagnetic devices, the impulse voltage measurement is determined in accordance with the rated mains voltage and Overvoltage Category III.

Table 2 (from DIN VDE 0110 Part 1: 1989-01 / IEC 60664-1)

Line-to-ground voltage in V, derived from rated mains voltage up to $U_{\text{eff}}$ and U	Impulse voltage measurement in V for Overvoltage Category			
	I	II	III	IV
50	330	500	800	1500
100	500	800	1500	2500
150	800	1500	2500	4000
300	1500	2500	4000	6000
600	2500	4000	6000	8000

#### 4.2 Current

##### Static rated current $I_{\text{stat}}$

The static rated current is the value measured at rated voltage, rated frequency, 20°C winding temperature and rated air gap in static (resting) condition.

The current is an effective value in this instance.

##### Dynamic rated current $I_{\text{dyn}}$

The dynamic rated current is measured as an effective value for vibrating solenoids during operation with the rated voltage in vibrating (dynamic) condition. (To do this, the static rated air gap must be set when the vibration system is resting.)

For vibrating solenoids that work via half-wave rectifiers in double-mass vibration systems with a natural frequency that is higher than the mechanical drive frequency, it is approximately:

$$I_{\text{dyn}} = 0.7 * I_{\text{stat}}$$

#### 4.3 Performance

##### Static performance $P_{\text{st}} = U_{\text{rated}} * I_{\text{stat}}$

The static performance for vibrating solenoids is the apparent performance with a rated air gap (braked anchor) while the solenoid is not vibrating (static) after the clearing process has died down.

##### Dynamic performance $P_{\text{dyn}} = U_{\text{rated}} * I_{\text{dyn}}$

The dynamic performance is the product of the effective current measured in vibrating (dynamic) condition and the applied rated voltage.

The dynamic performance also represents an apparent performance and is a rating for the thermal design of the vibrating solenoid. It should not be exceeded during operation due to the risk of thermal overload.



## 4.4 Frequency

IBK standard vibrating solenoids are designed for a rated frequency of 50 Hz from the alternating voltage supply. Vibrating solenoids intended for direct connection to the mains are potted with a brown potting compound. Should this be the case, the mechanical vibration frequency is equal to the doubled mains frequency of the alternating voltage supply.

e.g.  $50 \text{ Hz}_{\text{mains}} = 100 \text{ Hz}_{\text{mech.}} = 6000 \text{ vibrations/min}$

Vibrating solenoids intended for connection via a half-wave rectifier are potted with a grey potting compound. Should this be the case, the mechanical vibration frequency is equal to the mains frequency of the alternating voltage supply.

e.g.  $50 \text{ Hz}_{\text{mains}} = 50 \text{ Hz}_{\text{mech.}} = 3000 \text{ vibrations/min}$

Vibrating solenoids intended for connection via REOVIB frequency converter control systems (MFS) are also potted with a grey potting compound. Should this be the case, the mechanical vibration frequency is equal to the frequency shown on the display for the supplying MFS control system.

e.g.  $13 \text{ Hz}_{\text{control}} = 13 \text{ Hz}_{\text{mech.}} = 780 \text{ vibrations/min}$

## 5.0 Operating time, temperatures, thermal class

### 5.1 Operating time

IBK vibrating solenoids are essentially designed for a relative operating time of 100%, i.e. for continuous operation (CO). The operating time can be determined as follows, taking the different types of heating behaviour into consideration (DIN 0580):

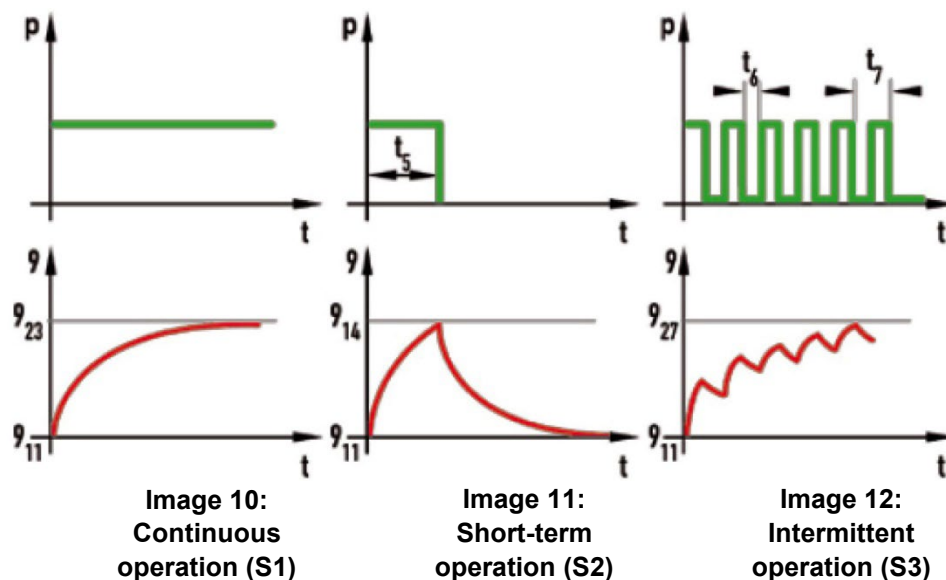

$t_5$  = operating time  
 $t_6$  = current-free break  
 $t_7$  = duty cycle  
 $p$  = electrical power

### 5.2 Temperature:

The reference temperature (output temperature) is the steady-state temperature when there is no current. The determined reference temperature (output temperature) is + 35 °C for IBK vibrating solenoids.

The overtemperature is the increase in temperature and/or heating compared to the reference temperature (output temperature).

The end overtemperature is the overtemperature at the end of a heating process. End overtemperatures for IBK vibrating solenoids are below the overtemperature limit for Thermal Class B (90 K).

The limit temperature is the permissible temperature determined for individual device components.

The overtemperature limit is the maximum permissible overtemperature. It comes from the limit temperature minus the sum of the reference temperature (output temperature) determined and the hotspot difference.

The hotspot difference is the difference between the median winding temperature and the temperature at the hottest winding point. The hotspot difference is stated at 5 K.

The measured overtemperature plus the reference temperature of 35 °C is considered to be the operating temperature.

The overtemperature for vibrating solenoids has been recorded based on the rated voltage and frequency when static (braked anchor) with a rated air gap and during continuous operation on a thermally insulated surface, avoiding additional heating or cooling influences on the test arrangement.

### 5.3 Thermal class

The insulation materials for vibrating solenoids are categorised under Thermal Class "B" with regards to their continuous resistance to heat.

For Thermal Class "B", in accordance with DIN IEC 85 (VDE 0301 Part 1), the following applies:

limit temperature 130 °C, limit overtemperature 90 K.

As vibrating solenoids connected to the vibrating system are exclusively mounted on iron in practice, good heat dissipation is guaranteed. However, insulating materials should be avoided.

### 6.0 IBK vibrating solenoid connection

In most cases, vibrating solenoids are connected to the alternating voltage supply via a half-wave rectifier, depending on the type. They are also directly operated via the alternating voltage supply.

Regulating transformers, thyristor control devices, frequency converts etc. are available as power supply devices and for continuous adjustment of the vibration range.

#### 6.1 Direct mains connection

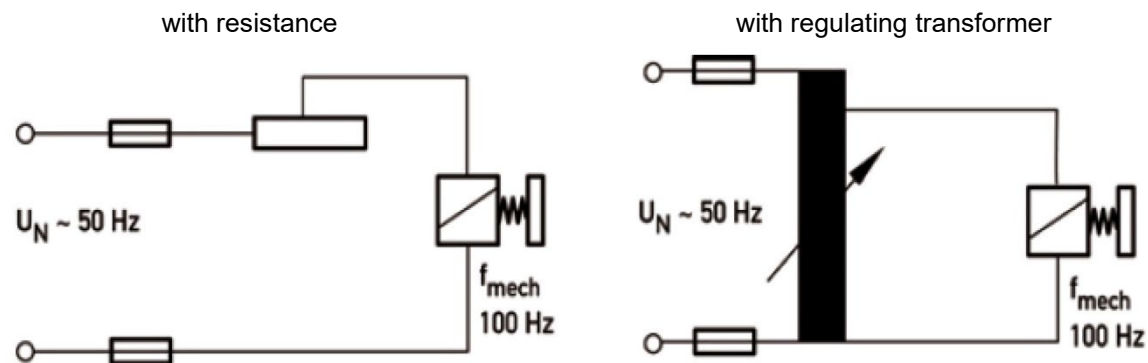

## 6.2 Connection via half-wave rectifier

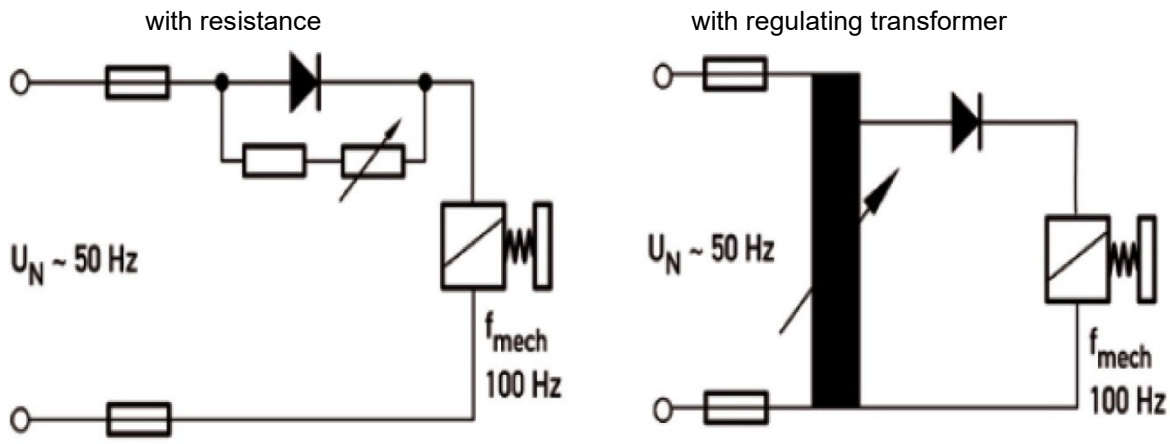

## 6.3 Thyristor and/or frequency converter control system

REO has a wide variety of control systems (see REOVIB).

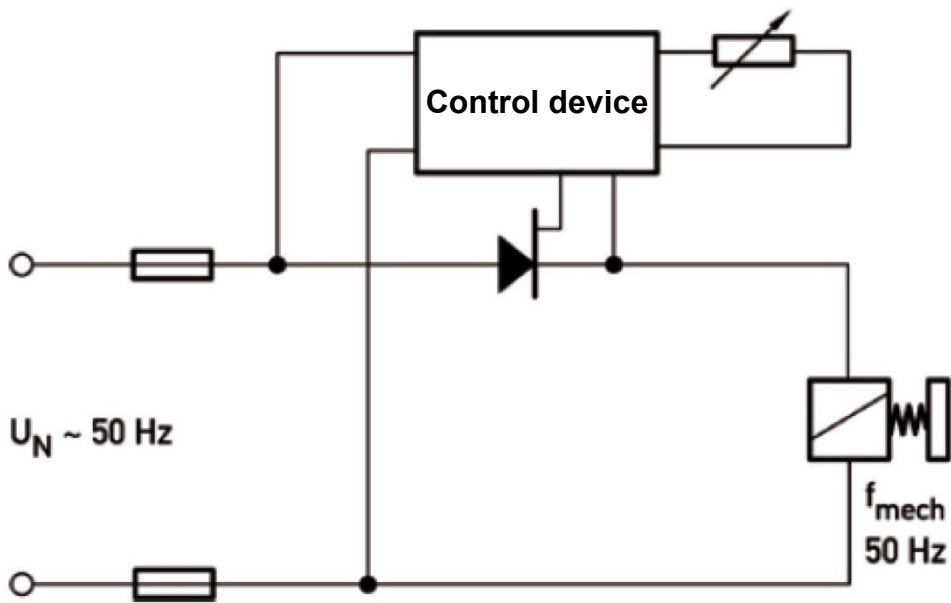

## 7.0 IBK vibrating solenoid - series

### 7.1 Series WI standard

Sizes: WI 111/ - WI 111/9  
 Voltage: 230 V ~  
 Power: 10 - 350 VA  
 Vibrations: 3000 / 6000 rpm  
 Air gap: 1 - 3 mm

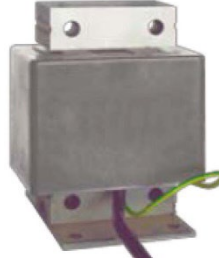

Type	max. Rated air gap	Connection at 50 Hz	Peak traction at max. Rated air gap	Connection via half-wave rectifier	Peak traction at max. Rated air gap	Weight kg	
	(mm)					(VA)	F(N)
<b>WI 111/3</b>	2	12	4	10	5	0.135	0.025
<b>WI 111/5</b>	1	60	55	47	38	0.405	0.085
<b>WI 111/6</b>	2.5	70	15	68	24	0.580	0.110
<b>WI 111/7</b>	3	138	43	129	45	1.150	0.165
<b>WI 111/9</b>	3	260	110	350	150	1.980	0.330

### 7.2 Series WI flat design

Sizes: WI 121/10 - WI 121/18  
 Voltage: 230 V ~  
 Power: 280 - 4160 VA  
 Vibrations: 3000 rpm  
 Air gap: 2.5 - 3 mm



Type	max. rated air gap	Connection at 50 Hz	Peak traction (approx.) at max. rated air gap	Weight kg	
	(mm)			(VA)	F(N)
<b>WI 121/10</b>	2.5	280	320	2.02	0.34
<b>WI 121/12</b>	3.0	425	500	2.8	0.62
<b>WI 121/14</b>	3.0	1200	1400	6.8	1.4
<b>WI 121/16</b>	3.0	2060	2700	10.5	2.6
<b>WI 121/18</b>	3.0	4160	6500	28	6

### 7.3 Series WI with changeover

Sizes: WI 211/7 - WI 211/10  
 Voltage: 100/200 V ~  
 Power: 175 - 240 VA  
 Vibrations: 3000 /6000 rpm  
 Air gap: 1 mm



Type	Performance (VA)	max. Rated air gap (mm)	Weight kg		Operating modes via jumpers for all types
			Magnet	Anchor	
<b>WI 211/7</b>	175	1.0	1.10	0.16	200 V 6000 rpm. 100 V 6000 rpm. G200 V 3000 rpm. G100 V 3000 rpm.
<b>WI 211/9</b>	210	1.0	1.96	0.30	
<b>WI 211/10</b>	240	1.0	1.83	0.30	

#### 7.4 Series WI for low frequencies

Sizes: WI 311/3 - WI 311/16  
 Voltage: 200 V ~  
 Power: 5.4 – 620 VA  
 Vibrations: 960 / 3600 rpm  
 Air gap: 2-6 mm



Type	max. Rated air gap (mm)	Connection to control systems VA	Peak traction (approx.) at max. rated air gap F(N)	Weight kg	
				Magnet	Anchor
WI 311/3	2.0	5.4	10 - 30	0.135	0.025
WI 311/5	2.0	20	10 - 30	0.405	0.085
WI 311/7	2.5	60	10 - 30	1.150	0.165
WI 311/9	3.0	126	17 - 30	1.980	0.330
WI 311/11	6.0	138	8 - 30	6.3	0.9
WI 311/14	3.0	340	13	6.8	1.4
WI 311/16	3.0	620	13 - 25	10.5	2.6

#### 7.5 Series WI with corrosion protection

Sizes: WI 411/3 - WI 411/9  
 WI 421/10 - WI 421/18  
 Voltage: 230 V ~  
 Power: 10 – 2060 VA  
 Vibrations: 3000 rpm  
 Air gap: 1-3 mm



Type	max. Rated air gap (mm)	Connection at 50 Hz VA	Peak traction (approx.) at max. rated air gap F(N)	Weight kg	
				Magnet	Anchor
WI 411/3	2.0	10	5	0.135	0.025
WI 411/5	1.0	47	38	0.405	0.085
WI 411/6	2.5	68	24	0.58	0.11
WI 411/7	3.0	129	45	1.15	0.165
WI 411/9	3.0	350	150	1.98	0.33
WI 421/10	2.5	280	320	2.02	0.34
WI 421/12	3.0	425	500	2.8	0.62
WI 421/14	3.0	1200	1400	6.8	1.4
WI 421/16	3.0	2060	2700	10.5	2.6
WI 421/18	3.0	4160	6500	28	6.0

### 7.6 Series WE standard

Sizes: WE 131/54 - WE 131/136  
 Voltage: 110/230 V ~  
 Power: 34 - 690 VA  
 Vibrations: 3000 rpm  
 Air gap: 0.25-0.8 mm



Type	Performance	Rated air gap (mm)	Weight kg		Connection configuration  G 110 V bl / br - sw / sw1  G 230 V bl - sw1 / br - sw
	(VA)		Magnet	Anchor	
<b>WE 131/54</b>	34	0.25	0.4	0.065	
<b>WE 131/66</b>	46	0.4	0.65	0.12	
<b>WE 131/75</b>	115	0.5	1.4	0.27	
<b>WE 131/135</b>	480	0.8	7.2	1.6	
<b>WE 131/136</b>	690	0.6	8.7	2.2	

### 7.7 Series WE with changeover

Sizes: WE 221/54 - WE 221/136  
 Voltage: 110/230 V ~  
 Power: 23 - 690 VA  
 Vibrations: 3000 / 6000 rpm  
 Air gap: 0.25-0.75 mm



Type	Performance	Rated air gap (mm)	Weight kg		Operating modes via jumpers for all types  230 V 6000 rpm. 110 V 6000 rpm. (without half-wave rectifier)  G230 V 3000 rpm. G110 V 3000 rpm. (with half-wave rectifier)
	(VA)		Magnet	Anchor	
<b>WE 221/54</b>	34	0.25	0.4	0.065	
<b>WE 221/66</b>	57	0.4	0.65	0.12	
<b>WE 221/75</b>	172	0.5	1.6	0.31	
<b>WE 221/76</b>	115	0.5	1.4	0.27	
<b>WE 221/135</b>	460	0.75	7.2	1.6	
<b>WE 221/136</b>	690	0.6	8.7	2.2	

### 7.8 Series WI with changeover

Sizes: WE 221/54 - WE 221/136  
 Voltage: 110/230 V ~  
 Power: 23 - 690 VA  
 Vibrations: 3000 / 6000 1/ min  
 Air gap: 0.25-0.75 mm



Type	Performance	Rated air gap (mm)	Weight kg		Operating modes via jumpers for all types  230 V 6000 1/min. 110 V 6000 1/min. (without half-wave rectifier)  G230 V 3000 1/min. G110 V 3000 1/min. (with half-wave rectifier)
	(VA)		Magnet	Anchor	
<b>WI 721/10</b>	320	2.5	2.1	0.34	
<b>WI 721/12</b>	450	3	2.8	0.62	
<b>WI 721/14</b>	1200	3	6.9	1.45	
<b>WI 721/16</b>	2200	3	10.5	2.6	
<b>WI 721/18</b>	--	3	28	9	

## 8.0 Options for connecting vibrating solenoids to REOVIB control systems

Essentially, all solenoid types can be operated with frequency control systems - on condition that the output frequency of the control is customised to the solenoid.

### Special solenoids for the low-frequency range:

The device is controlled by frequency control systems, such as REOVIB MFS 168, MFS 268

Type	max. Rated air gap	Performance	Frequency range
	(mm)	VA	(Hz)
<b>WI 311/3</b>	2.0	5.4	10 - 30
<b>WI 311/5</b>	2.0	20	10 - 30
<b>WI 311/7</b>	2.5	60	10 - 30
<b>WI 311/9</b>	3.0	126	17 - 30
<b>WI 311/11</b>	6.0	138	8 - 30
<b>WI 311/14</b>	3.0	340	13
<b>WI 311/16</b>	3.0	620	13 - 25

These solenoids are used with medium-sized drives as an alternative to unbalance motors.

The magnetic power can be increased by switching on several solenoids in parallel.

The maximum permissible current and air gap should always be taken into account when using the solenoid.

The steady-state temperature of the solenoid may only be reached after 9 hours, depending on its use.

Solenoids for use at mains frequencies (50/60 Hz):

The vibration range is controlled by thyristor control systems, such as REOVIB R6/439 or REOVIB MTS 440, MTS 442.

Type	max. Rated air gap (mm)	Connection to 50 Hz 6000 vibrations (VA)	Peak traction at max. Rated air gap F(N)	Connection via half-wave rectifier (VA)	Peak traction at max. Rated air gap F(N)
<b>WI 111/3</b>	2	12	4	10	5
<b>WI 111/5</b>	1	60	55	47	38
<b>WI 111/6</b>	2.5	70	15	68	24
<b>WI 111/7</b>	3	138	43	129	45
<b>WI 111/9</b>	3	260	110	350	150

Type	Rated air gap (mm)	Performance (VA)	Voltage (V)	Vibrations (rpm)
<b>WE 221/66</b>	0.4	57	230	6000
<b>WE 131/66</b>	0.4	46	230	3000
<b>WE 131/135</b>	0.8	480	230	6000
<b>WE 131/136</b>	0.6	690	230	6000

The potting compound is brown for solenoids for full-wave operation (6000 vibrations or 100 Hz).

The potting compound is grey for solenoids for half-wave operation (3000 vibrations or 50 Hz).

Solenoids for use at mains frequencies (50/60 Hz) are reversible 100/200 V.

Type	max. Rated air gap (mm)	Performance (VA)	Operating modes via jumpers for all types
<b>WI 211/7</b>	1.0	175	200 V 6000 rpm. 100 V 6000 rpm. G200 V 3000 rpm. G100 V 3000 rpm.
<b>WI 211/9</b>	1.0	210	
<b>WI 211/10</b>	1.0	240	

Type	max. Rated air gap (mm)	Performance (VA)	Voltage (VA)	Vibrations (rpm)
<b>WE 131/54</b>	0.25	34	G110/G230	3000
<b>WE 131/66</b>	0.4	46	G110/G230	3000
<b>WE 131/75</b>	0.5	115	G110/G230	3000

Solenoids for use at mains frequencies (50/60 Hz) with a higher performance:

The vibration range is controlled by thyristor control systems, such as REOVIB R15/469 or REOVIB R25/499.

Type	max. rated air gap (mm)	Connection to 50 Hz (VA)
<b>WI 121/10</b>	2.5	280
<b>WI 121/12</b>	3.0	425
<b>WI 121/14</b>	3.0	1200
<b>WI 121/16</b>	3.0	2060
<b>WI 121/18</b>	3.0	4160



## **REOVIB - MFS global player**

There is no uniform international mains frequency. The use of thyristor devices to control vibrating conveyors therefore inevitably results in differently coordinated spring and mass systems at different mains frequencies. The frequency converters REOVIB - MFS series, specially designed for vibrating conveyors, get rid of this disadvantage, the mains frequency now no longer plays a part. However, it is still not enough: these devices offer even more and greater benefits with regards to aligning the conveyor system with the drive frequency, which has always been required until now.

### **Control devices**

The majority of control devices for vibrating conveyors work with thyristors and/or TRIACs in phase angle control. The conveyor power of the vibrating conveyor can be continuously adjusted in this way, but the vibration frequency of the conveyor is rigidly coupled to the mains frequency of the supplying mains. Depending on the drive, the conveyor can vibrate at the same frequency as the mains (e.g. 50 Hz) when controlled by only one sine half-wave, or at twice the frequency (e.g. 100 Hz) when controlled by both sine half-waves. However, it is not possible to deviate from this combination. Consequently, the natural frequency of the mechanical vibration system must be adapted to the mains frequency. Different coordinated conveyor systems are therefore mandatory for countries with mains frequencies of 50 Hz and/or 60 Hz. This fact is particularly problematic for exports to such countries, but it is also an obstacle for internationally active companies, as manufacturing systems are not transferable in the circumstances.

### **Springs, air gaps and weights**

Naturally, mechanically aligning the vibrating system with the mains frequency is a time-consuming and, depending on the size of the conveyor, it is also a difficult matter that requires help, making it expensive as a result. This is even more evident when the conveyor drive needs to be retrofitted to another conveyor product and/or feeder bowl, but in the age of flexible automation, the demand for conveyors for different products is growing. In these instances, the different feeder bowls must be balanced with weights, which is even more time-consuming, requires material usage and is often subject to compromises.

The REOVIB - MFS series frequency converters, specially designed for operation with vibrating conveyors, are now in a position to generate a highly stable, adjustable drive frequency for the conveyor device, regardless of the frequency of the supply voltage. The drive frequency can now be aligned with the conveyor in steps of 0.1 Hz - there is therefore no need for mechanical alignment with the mains frequency.

## **From spanners to electronics**

After the mechanical assembly of the conveyor system with standard spring packages and components, fine-tuning can be carried out to ensure that the device as a whole runs optimally, purely by electronic means. In the most convenient case, the control device uses a patented procedure to independently search for the resonance frequency of the conveyor system, and saves this for further operation in practice.

Changing loads caused by more or less material in the feeder bowl also no longer play a part when the vibration range is kept constant in regular operation. The conveyor speed is adjusted in turn by the variable output voltage of the device. A combination of voltage regulation and active frequency tracking during operation can also be turned on during regular operation. The vibrating conveyor then always operates optimally at its resonance frequency. This provides a further benefit in terms of the energy balance: The power taken from the mains is reduced by approx. 1/3 compared to conventional control devices. Due to the sine-shaped output current, the conveyor achieves a high level of engine smoothness, the conveyor parts are easier to sort, and the noise level decreases. Other functions are also integrated via the pure drive function of the conveyor, such as fill level control and sensor monitoring, as well as input/output signals for linking with other devices and higher-level control systems.



A high level of user-friendliness is achieved through the use of a display and settings via keys. Accurate and reproducible settings are easily made with the aid of the numeric display. User-specific settings can be saved and retrieved.

### **In summary, the main advantages:**

- No time-consuming alignment of the mechanical spring system.
- The drive frequency of the conveyor is always the same, regardless of the mains frequency.
- Easy to adjust frequency when feed bowls are changing
- Independent search for resonance frequency
- High level of engine smoothness thanks to sine-shaped output current
- Integrated control functions
- Highly reproducible settings thanks to digital operation

**REO - the full programme for the right drive**

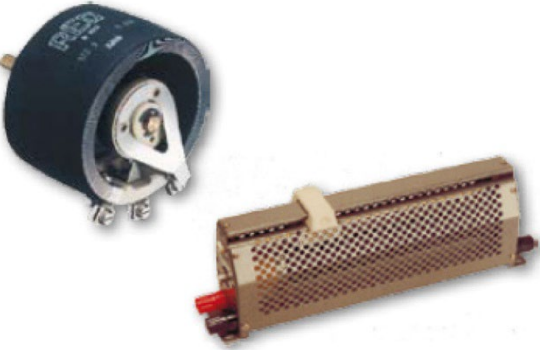
<p><b>REOVAR</b> Regulating transformers with toroidal core, with economy or separate winding</p>	<p><b>REOSTAT</b> Fixed and adjustable resistors in ring or tube design</p>
	

**REOVIB**  
The term REOVIB includes control devices and components for conveyor technology.

<ul style="list-style-type: none"> <li>- simple control devices</li> <li>- Control devices with additional functions for material control</li> <li>- Housing design and switch cabinet versions</li> </ul>	
<p><b>Thyristor and/or TRIAC control systems</b></p>	<p><b>Frequency converters</b></p>
	
<ul style="list-style-type: none"> <li>- Accelerometers</li> <li>- Measuring devices for vibration range displays</li> <li>- Measuring devices for vibration frequency, vibration range, vibration acceleration</li> <li>- Measuring devices with threshold value monitoring</li> </ul>	
<p><b>Monitoring devices for vibrating conveyors</b></p>	<p><b>Sensors for vibration monitoring</b></p>
	

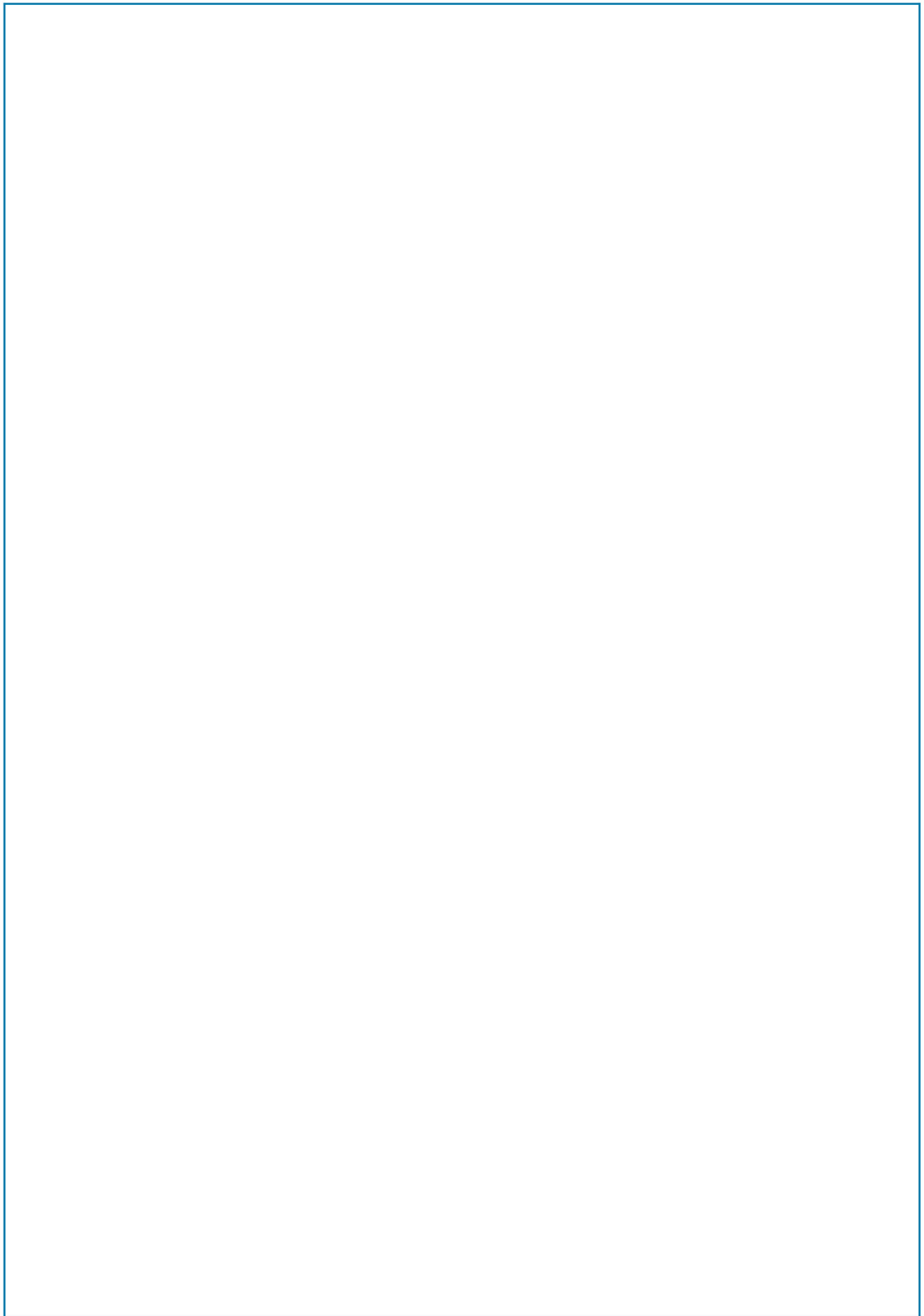



REO AG

Brühler Straße 100 • D-42657 Solingen  
Phone: +49 (0)212 8804 0 • Fax: +49 (0)212 8804 188

Email: [info@reo.de](mailto:info@reo.de)  
Internet: [www.reo.de](http://www.reo.de)

#### ■ Divisions:

##### **Vibratory Feeding and Power Electronics Division**

**REO Vibratory Feeding and Power Electronics Division**  
Brühler Straße 100 • D-42657 Solingen  
Phone: +49 (0)212 8804 0 • Fax: +49 (0)212 8804 188  
Email: [info@reo.de](mailto:info@reo.de)

##### **Train Technologies Division**

**REO Train Technologies Division**  
Erasmusstraße 14 • D-10553 Berlin  
Phone: +49 (0)30 3670236 0 • Fax: +49 (0)30 3670236 10  
E-mail: [zentrale.berlin@reo.de](mailto:zentrale.berlin@reo.de)

##### **Drives Division**

**REO Drives Division**  
Holzhausener Straße 52 • D-16866 Kyritz  
Phone: +49 (0)33971 485 0 • Fax: +49 (0)33971 485 90  
E-mail: [zentrale.kyritz@reo.de](mailto:zentrale.kyritz@reo.de)

##### **Medical and Current Transformer Division**

**REO Medical and Current Transformer Division**  
Schuldholzinger Weg 7 • D-84347 Pfarrkirchen  
Phone: +49 (0)8561 9886 0 • Fax: +49 (0)8561 9886 40  
E-mail: [zentrale.pfarrkirchen@reo.de](mailto:zentrale.pfarrkirchen@reo.de)

##### **Test and PowerQuality Division**

**REO Test and PowerQuality Division**  
Brühler Straße 100 • D-42657 Solingen  
Phone: +49 (0)212 8804 0 • Fax: +49 (0)212 8804 188  
Email: [info@reo.de](mailto:info@reo.de)

#### PRODUCTION + SALES:

- **China**  
REO Shanghai Inductive Components Co., Ltd  
Email: [info@reo.cn](mailto:info@reo.cn) • Internet: [www.reo.cn](http://www.reo.cn)
- **India**  
REO GPD INDUCTIVE COMPONENTS PVT. LTD  
Email: [info@reogpd.com](mailto:info@reogpd.com) • Internet: [www.reo-ag.in](http://www.reo-ag.in)
- **USA**  
REO-USA, Inc.  
Email: [info@reo-usa.com](mailto:info@reo-usa.com) • Internet: [www.reo-usa.com](http://www.reo-usa.com)  
SALES:
- **France**  
REO VARIAC S.A.R.L.  
Email: [reovariac@reo.fr](mailto:reovariac@reo.fr) • Internet: [www.reo.fr](http://www.reo.fr)
- **Great Britain**  
REO (UK) Ltd.  
Email: [main@reo.co.uk](mailto:main@reo.co.uk) • Internet: [www.reo.co.uk](http://www.reo.co.uk)
- **Italy**  
REO ITALIA S.r.l.  
Email: [info@reitalia.it](mailto:info@reitalia.it) • Internet: [www.reitalia.it](http://www.reitalia.it)
- **Poland**  
REO CROMA Sp.zo.o  
Email: [croma@croma.com.pl](mailto:croma@croma.com.pl) • Internet: [www.croma.com.pl](http://www.croma.com.pl)
- **Spain**  
REO ESPAÑA 2002 S.A.  
Email: [info@reospain.com](mailto:info@reospain.com) • Internet: [www.reospain.com](http://www.reospain.com)
- **Switzerland**  
REO ELEKTRONIK AG  
Email: [info@reo.ch](mailto:info@reo.ch) • Internet: [www.reo.ch](http://www.reo.ch)
- **Turkey**  
REOTURKEY ELEKTRONIK San. ve Tic. Ltd. Şti.  
Email: [info@reo-turkey.com](mailto:info@reo-turkey.com) • Internet: [www.reo-turkey.com](http://www.reo-turkey.com)