

REO

## Protection classes

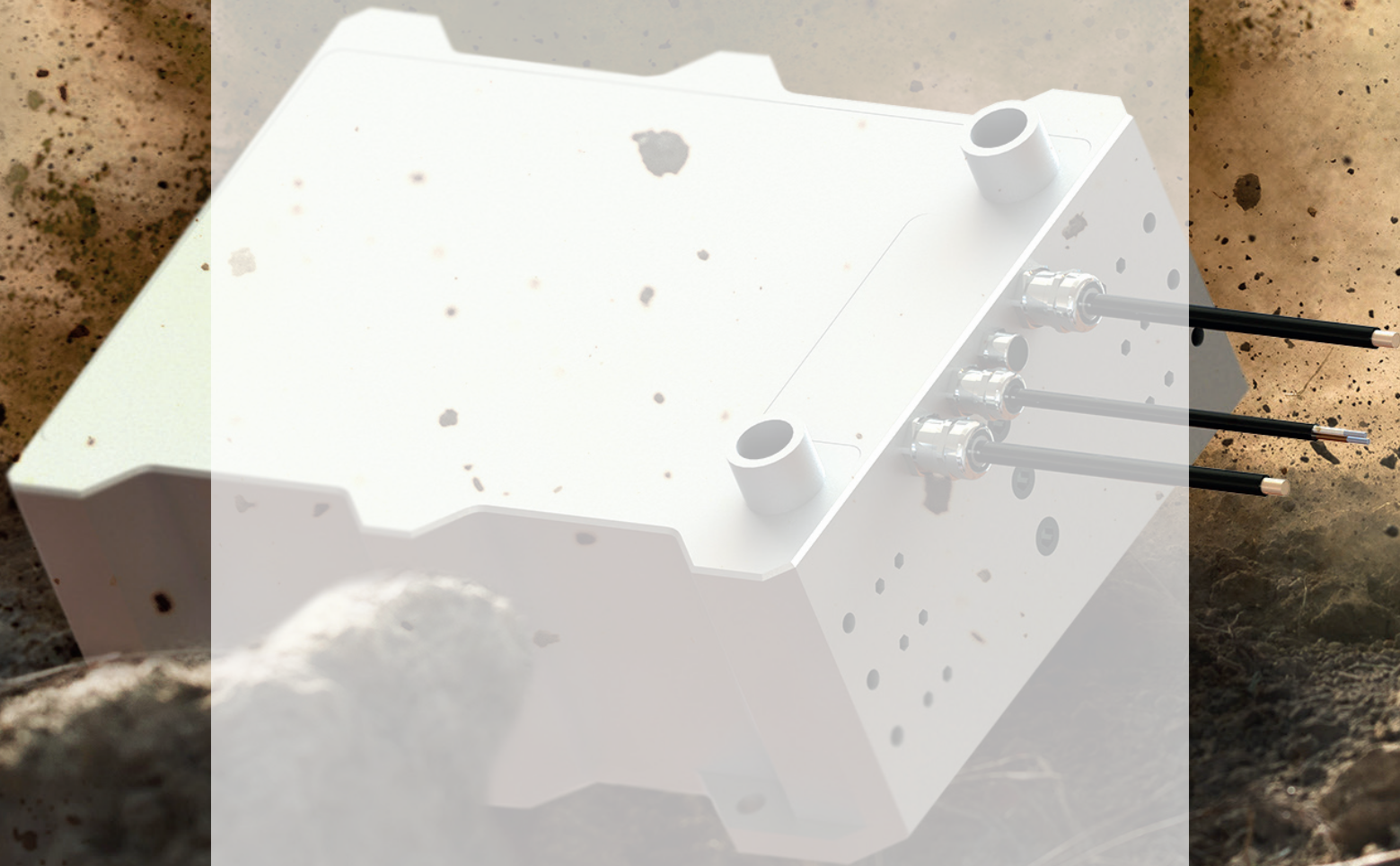

# Protection classes

REO achieve highest IP protection class	P. 3
REO system components	P. 6
IP Protection class – Explanation	P. 7
Protection class	P. 8
Highest IP protection class IP66	P. 9
Three-phase mains chokes 4% Uk	P. 10
du/dt-Filter	P. 11
Motor chokes	P. 12
Sinusoidal filter	P. 13
High protection classes up to IP66 - Braking resistors	P. 14
Protection classes of REO compact resistors	P. 15
Useful facts about REOhm resistors	P. 16-17
REOhm Series BW 15X	P. 18-19
Compact Braking resistor BW 155	P. 20-21
Compact Braking resistor BW 155 - combination	P. 22-23
Compact Braking resistor BW 156	P. 24-25
Compact Braking resistor BW D 158	P. 26-27
Compact Braking resistor BW D 330	P. 28-29
Applicable standards	P. 30

## REO achieve highest IP protection class (International Protection)

With components up to IP67

Electrical equipment is often required to work safely and reliably for many years under the most difficult conditions. In industry often aggressive substances - for example fuels, vapours and bases - are used and it is necessary to ensure that electronic devices work properly there too. In addition, the ingress of dust and water must be prevented.

The parameters give the user information about the usability of electrical equipment in certain environments. Furthermore the parameters tell us about the protection for people.

The degrees of protection are divided into IP ratings. The two following parameters to "IP" provide information about the environments in which the device can be used. These codes are defined in the standard IEC 529 (DIN EN 60529 / VDE 0470, T1).

The IP65 / 66 devices from REO can be used outside of the cabinet next to the frequency converter. Due to its special structure, the components are protected from dust and moisture. Required EMC specifications are achieved by the use of shorter cable lengths. The resulting increase of energy efficiency also reduces operating costs.

REO solutions are easy to install and user-friendly. They are particularly suitable for applications such as pumps, fans, conveyors, cranes, hoists, compressors and lifts.

### REO Advantages

- The special design ensures external mounting outside of the inverter without the need for an additional enclosure
- Particularly robust
- Protection from dust, liquids and slurries
- EMC Filters with special design provide corrosion - and salt water protection
- Very good heat dissipation
- Worldwide production facilities and sales offices





**High heat dissipation**

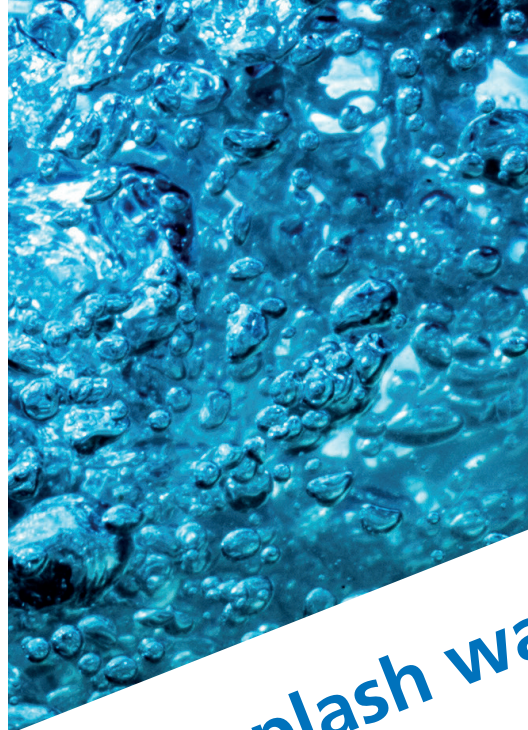

**High splash wa**







**Water protection**



**High dust protection**



# REO system components

With high protection IP ratings for inverters

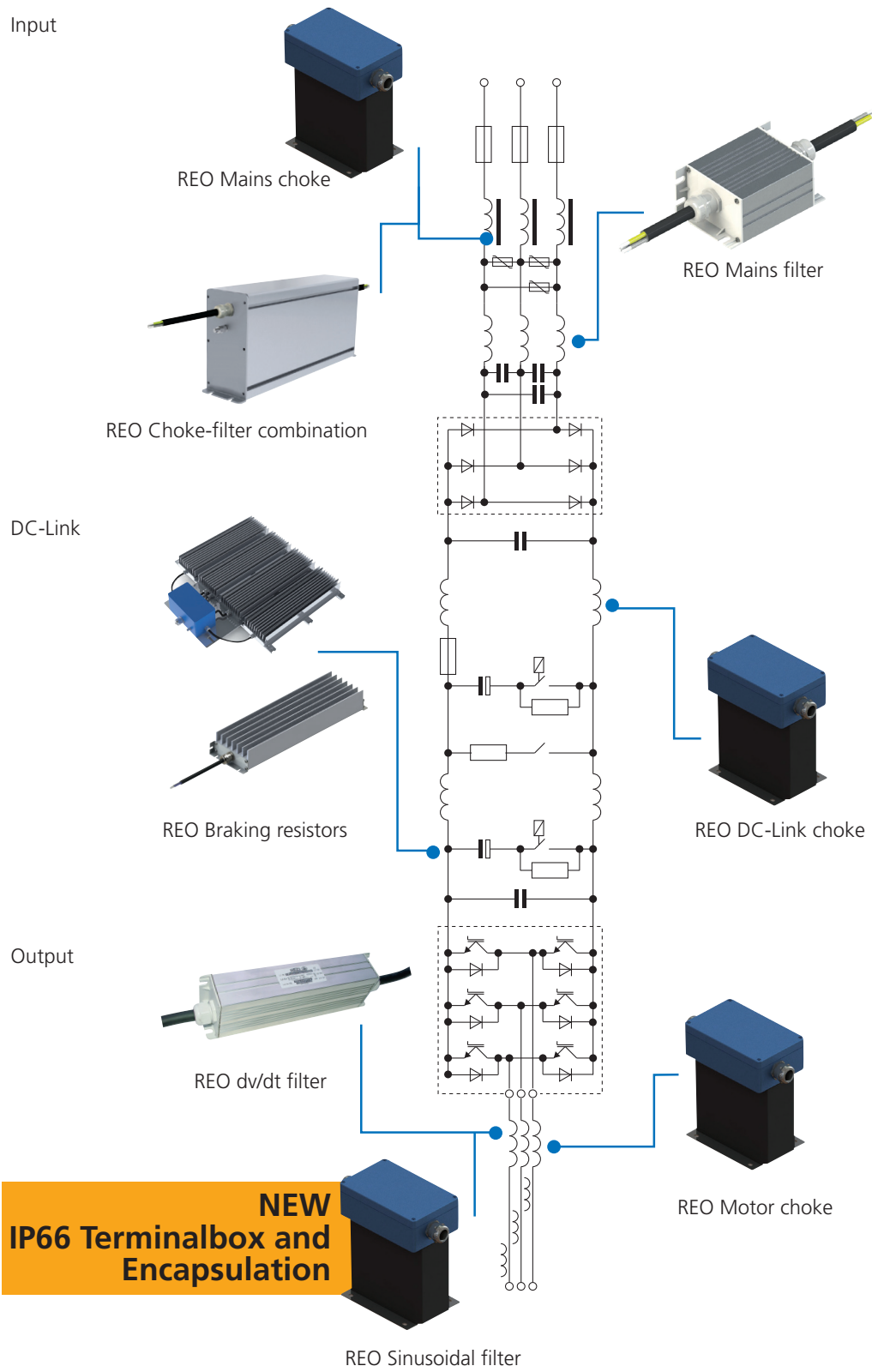



**NEW**  
**IP66 Terminalbox and Encapsulation**











# IP Protection class – Explanation

Below is a list of the classification of degrees of protection IP according to DIN EN 60529. The first parameter after IP has the meaning of protection against contact and foreign bodies and the second parameter describes the scope of protection against moisture and water.

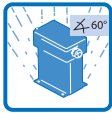
## 1. Parameter: Protection against contact and foreign bodies

- 0  No protection
- 1  Large foreign bodies  
(diameter from 50 mm upwards)  
 $\varnothing > 50\text{mm}$
- 2  Medium foreign bodies  
(diameter from 12,5 mm upwards, Length up to 80 mm)  
 $\varnothing > 12\text{mm}$
- 3  Small foreign bodies  
(diameter from 2,5 mm upwards)  
 $\varnothing > 2,5\text{mm}$
- 4  Grain-shaped foreign bodies  
(diameter from 1mm upwards)  
 $\varnothing > 1\text{mm}$
- 5  Ingress of dust is not entirely prevented
- 6  No ingress of dust

## 2. Parameter: Protection against water

- 0  No protection
- 1  Protection against dripping water  
(vertically falling drops)
- 2  Protection against oblique  
(up to 15°) falling water
- 3  Protection against Water  
falling as a spray at any angle  
up to 60° from the vertical
- 4  Protection against splash  
water from all sides
- 5  Protection against water  
coming from a nozzle
- 6  Protection against powerfull  
water coming from a nozzle  
(Flooding)
- 7  Protection against  
temporary immersion
- 8  Protection against  
permanent immersion
- 9  Protection against water during  
high pressure cleaning and Steam  
jet cleaning  
(applies only to road vehicles)



## Usual types of protection in practice

Common industrial systems in closed factories generally require IP20 protection. Here the protection IP54 (splash-proof + Dust-proof) is becoming more common. Outdoor systems

need protection to IP65 / 66 (Dustproof + watersplash safe). Protection  $\leq$  IP40 only offers protection against contact and is only useful when the system is installed in an enclosure.

## IP protection class – Typical Applications

The need for accessories for frequency converters with high protection is rapidly increasing. As frequency converters are being used in more applications and in more aggressive environments. The market is demanding these types of protection systems and REO offers a wide range of standard

products in aluminium profile: chokes (motor chokes, output chokes, sinusoidal filters) in encapsulated versions as the CNW M, EMC filters (CNW) and resistors (REOHN). The manufacturers of frequency converters now offer devices up to IP66.

## Advantages

The advantage of using high IP rated products is that a cost saving is made, as an expensive enclosure is no longer necessary.



## Highest IP protection class IP66

For REO chokes

To receive such a high protection class for chokes, REO has developed the patented encapsulation. With the combination of the completely protected terminal box, the equipment could be placed outside of the frequency converter. Therefore the additional costs of switch cabinets can be saved.

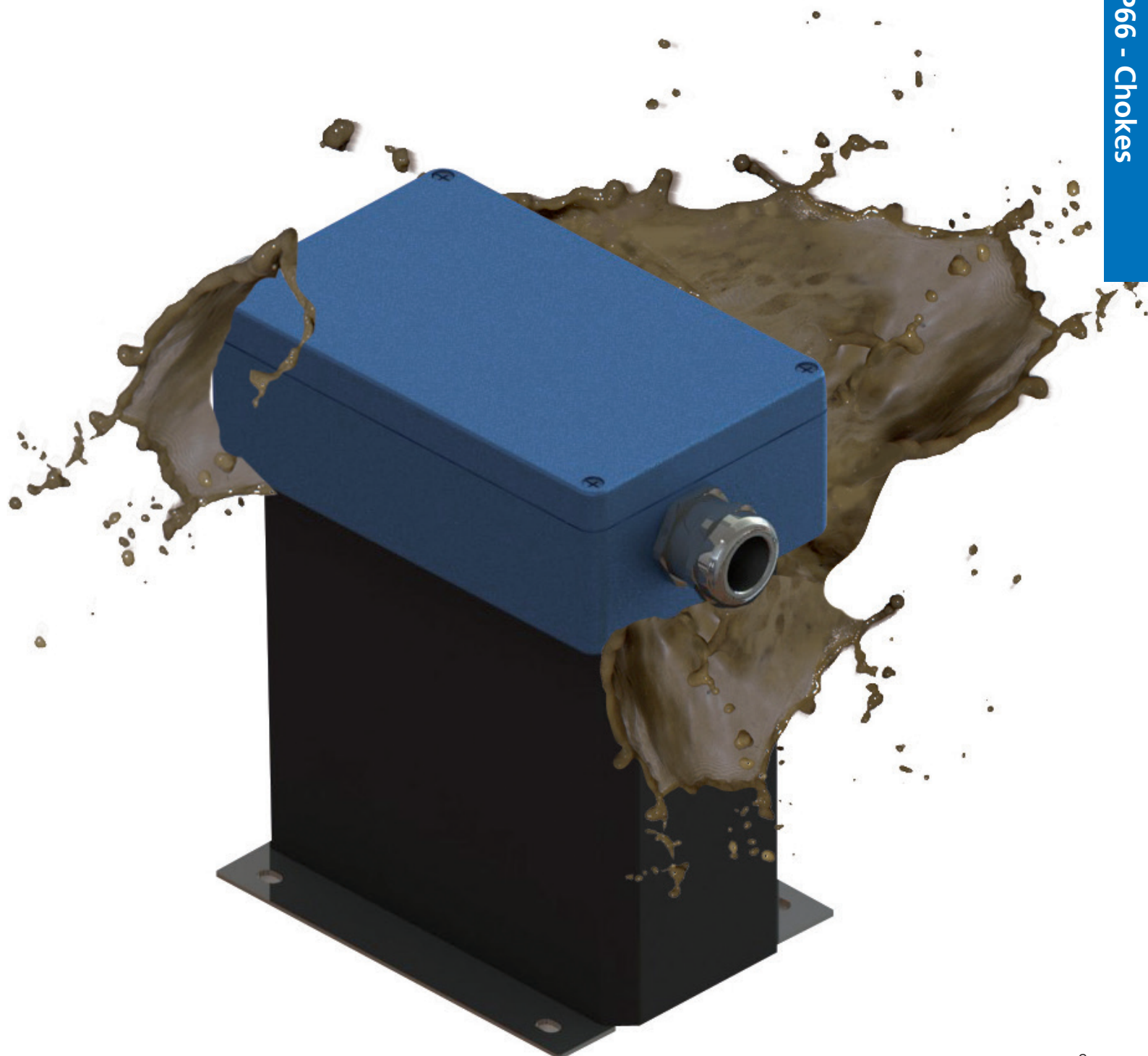

# Three-phase mains chokes 4% Uk Protection class up to IP66

(3 x 500 V) (3 A- 36 A), CNW M 903 / IP

## Advantages

- Compact encapsulated unit
- Optimal mechanical protection of the choke
- Lower surface temperature
- Easy connection
- Low noise

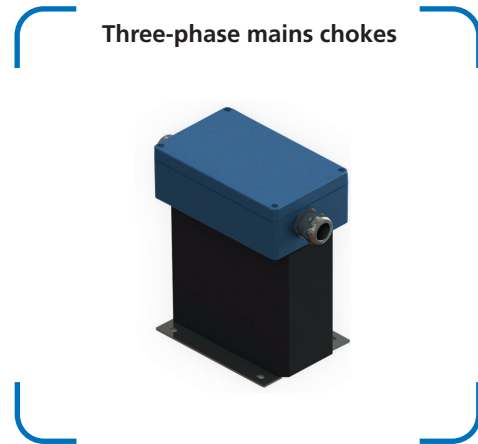

## Technical data

Three-phase mains chokes 4% Uk*						
Type	Rated voltage [V]	Rated current [A]	Uk	Inductance [mH]	Copper weight [kg]	Total weight [kg]
CNW M 903 / 8 / IP	up to 3 x 500 V	8	4%	3,6	1,0	2,4
CNW M 903 / 16 / IP		16	4%	1,8	1,6	4,6
CNW M 903 / 36 / IP		36	4%	0,81	2,5	6,6

Applications: Used on the input side of the inverter, reduction of harmonics and reduction of commutation losses, Test voltage L-L 2100 V, DC 1 s, L-PE 2700 V, DC 1s, Overload  $1,5 \times I_{Nenn}$  1 min / h, Climatic category DIN IEC 60068-1

Circuit example

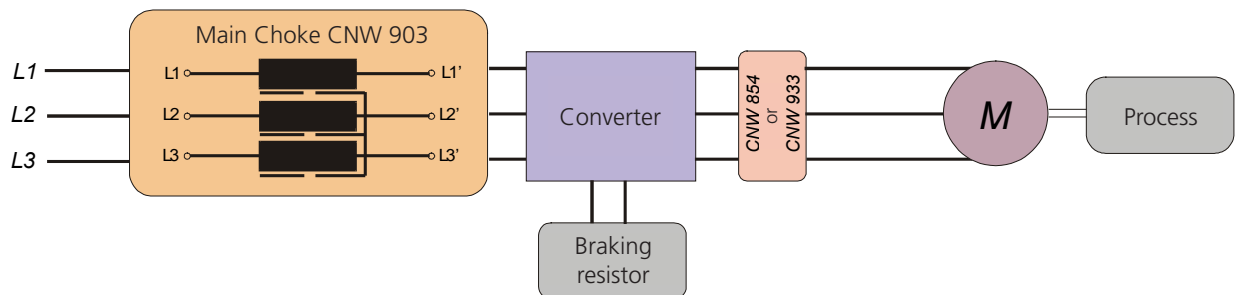



# du/dt-Filter Protection class up to IP66

(3x400V) (8-180A) CNW M 833/IP

## Advantages

- Low leakage current to the motor
- Optimal mechanical protection of the choke
- Low noise
- Easy connection
- Lower surface temperature

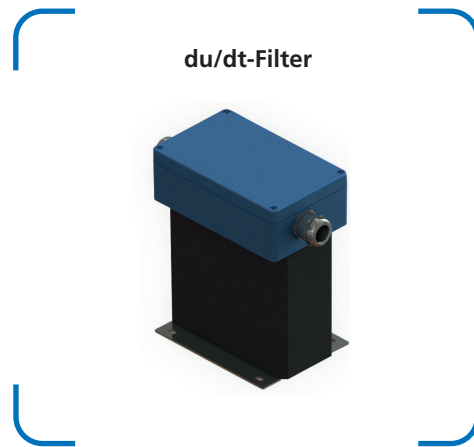

## Technical data

du/dt-Filter*					
Type	Rated voltage [V]	Rated current [A]	Inductance [mH]	Capacity [pF]	Total weight [kg]
CNW M 833 / 8 / 2 / IP	3 x 400 V ≤ 60 Hz	8	2	330	3,3
CNW M 833 / 16 / 0,9 / IP		16	0,9	330	4,5
CNW M 833 / 36 / 0,42 / IP		36	0,42	1500	9

Applications: The dv/dt filter is used to reduce the voltage slew rate at the drive, for increased motor life by reducing the voltage peaks: Test voltage 2500 Vdc, Climatic category DIN IEC 60068-1

**All chokes (CNW M 833 und CNW M 933) are available up to 180 A - just contact us.**

Circuit example

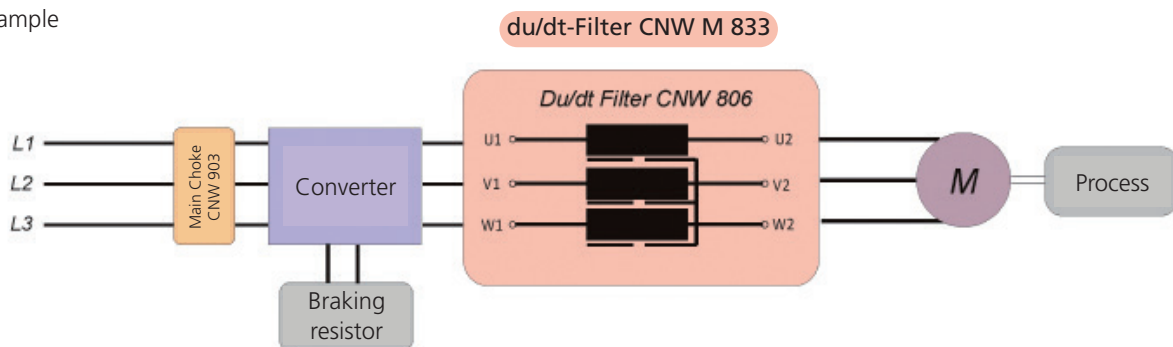

\*The given values are only an extract of the standard sizes

# Motor chokes Protection class up to IP66

(3 x 500V) (2A - 36A) CNW M 854 / IP

## Advantages

- Compact encapsulated unit
- Optimal mechanical protection of the choke
- Low noise
- Easy connection
- Lower surface temperature

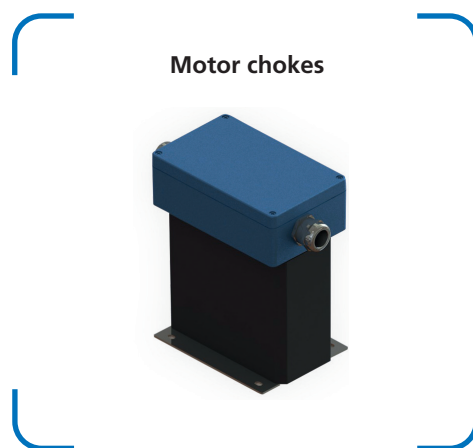

## Technical data

Motor chokes*					
Type	Rated voltage [V]	Rated current [A]	Inductance [mH]	Copper weight [kg]	Total weight [kg]
CNW M 854 / 8 / IP	up to 3 x 500 V	8	2,0	0,5	1,7
CNW M 854 / 16 / IP		16	0,9	1,1	3,2
CNW M 854 / 36 / IP		36	0,4	2,1	6,6

Applications: Increased motor life Reduction of dv/dt to earth and between the phases Reduction of motor noise: Test voltage L-L 2100 V, DC 1 s; L-PE 2700 V, DC 1s, Overload  $1,5 \times I_{Nenn}$  1 min / h, Climatic category DIN IEC 60068-1

Circuit example

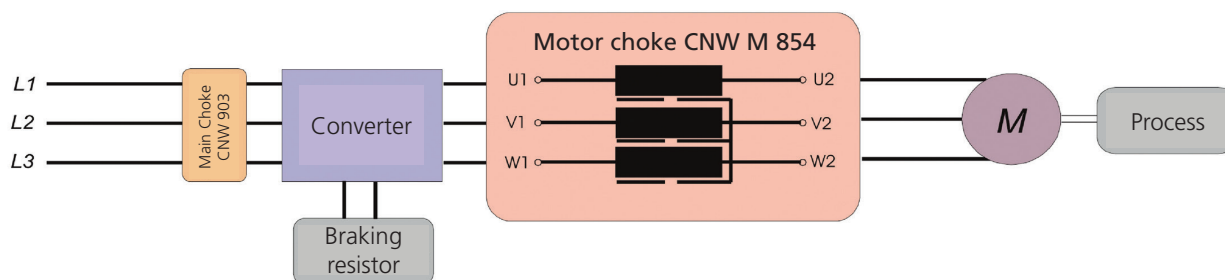



# Sinusoidal filter Protection class up to IP66

(3 x 500 V) (2 A – 37 A) CNW M 933 / IP

## Advantages

- Use in demanding environments
- Optimal mechanical protection of the choke
- Easy connection
- Lower surface temperature

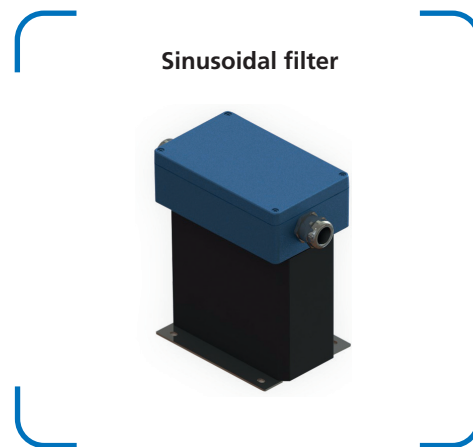

## Technical data

Sinusoidal filter					
Type	Rated voltage [V]	Rated current [A]	U <sub>k</sub>	Inductance [mH]	Copper weight [kg]
CNW M 933 / 8 / IP	up to 3 x 500 V	8	7,3	0,73	3,7
CNW M 933 / 16 / IP		16	3,6	1,1	9,2
CNW M 933 / 36 / IP		36	1,6	3,3	28,8
CNW M 933 / 48 / 1,2 / IP	3 x 400 V ≤ 60 Hz	48	1,2	10	32
CNW M 933 / 60 / 0,9 / IP		60	0,9	20	32,5
CNW M 933 / 90 / 0,65 / IP		90	0,65	25	55
CNW M 933 / 175 / 0,3 / IP		175	0,3	120	115

Applications: The output current and voltage on a frequency converter are converted into a sine-wave, suitable for long motor cable runs, increased motor life, reduction of noise, test voltage L-L 2100 V, DC 1 s, L-PE 2700 V, DC 1s, Overload 1,5 x I<sub>Nenn</sub> 1 min / h, Climatic category DIN IEC 60068-1

Circuit example

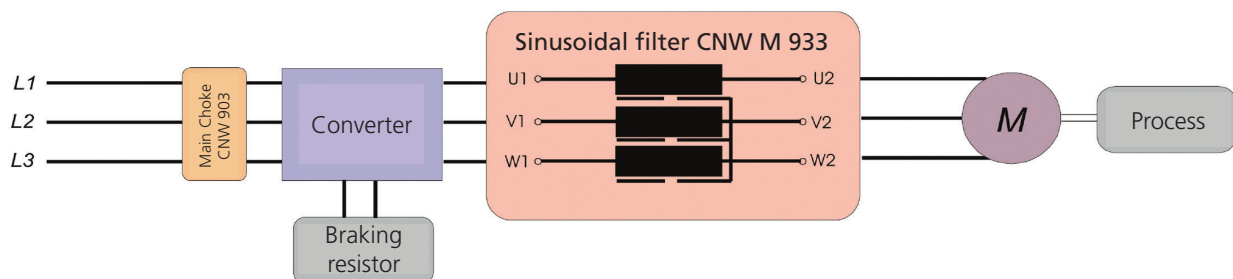

## High protection classes up to IP66

for REO Braking resistors

The protection describes the specific environment for electrical equipment. Especially in aggressive environments, climates with high temperature variations or other severe climatic conditions, using products with a high protection class is essential. The profile resistors of the REO<sub>hm</sub> series BW 150 with high protection class are especially suitable for aggressive environments, like marine applications or in railway technology.

Another large application is the wind power technology - there you can use the resistors for azimuth-drives or pitch systems.

These components can be mounted externally and are protected against external environmental issues. Often the components are mounted outside the switching cabinet - therefore it is a requirement to select a resistor with a high protection class. REO understand this philosophy and have a large standard range of inductors (CNW M), EMC filters (CNW) and resistors (BW).

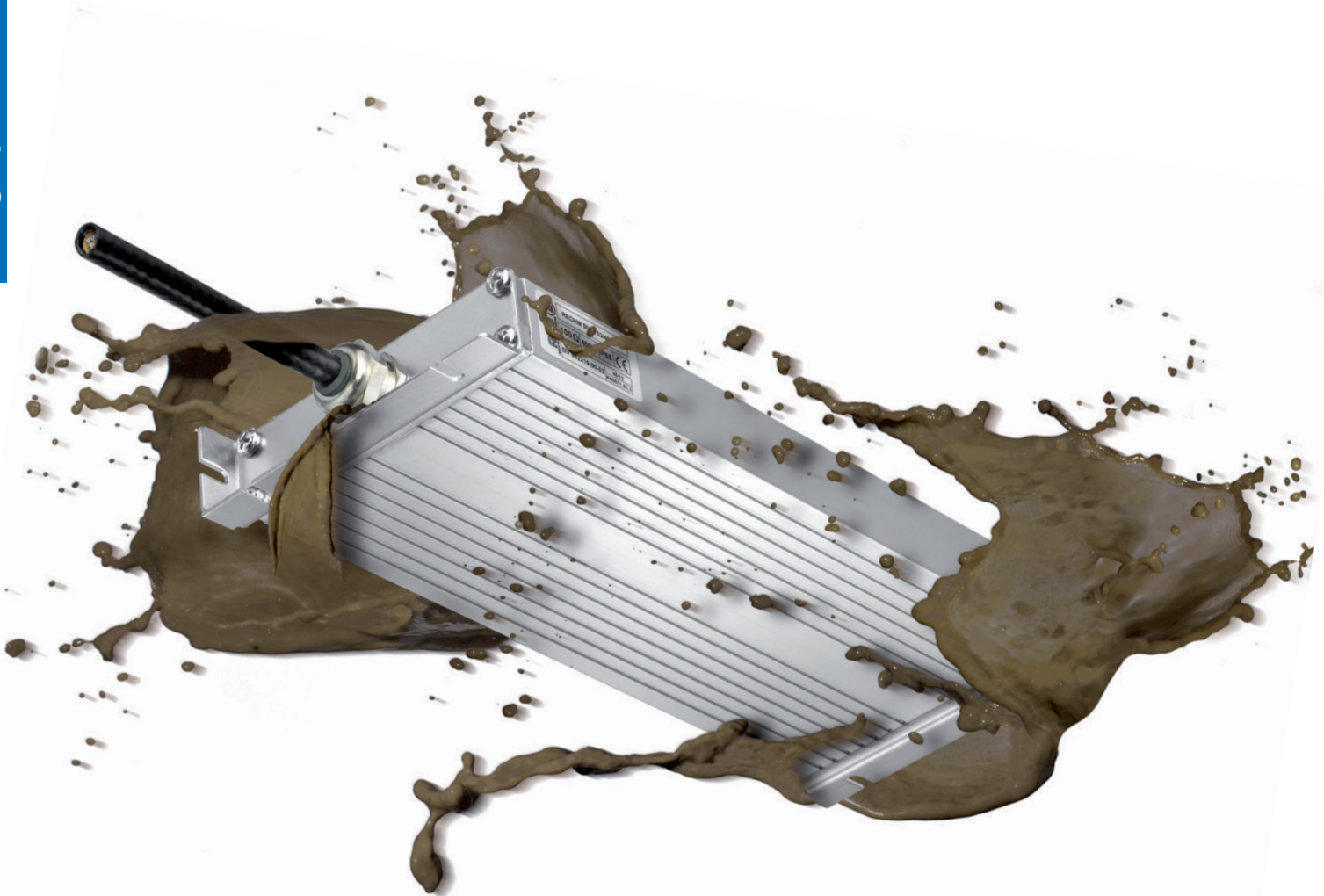



## Protection classes of REO compact resistors

Depending on the location and the environment, different protection classes are required. For the protection class  $\leq$ IP40 the temperature rise at the hottest point of the surface resistance is a maximum of 300K. For higher protection classes ( $>$ IP40) a maximum of 200K at the hottest point of the surface resistance is permitted.

Attention!!! Continuous high temperature of  $>$  200 K leads to a reduction of ingress protection.

## Additional temperature protection

It is possible to monitor the temperature of the resistor with a temperature switch. When exceeding a nominal temperature the temperature switch opens and triggers an alarm contact. The temperature switch is mounted externally for IP20 / IP40 versions and fitted with 2 wires ready for connection.

In a protection class IP54 / IP65 or higher, the temperature switch is integrated in the resistance and provides the connection for an external monitoring system.

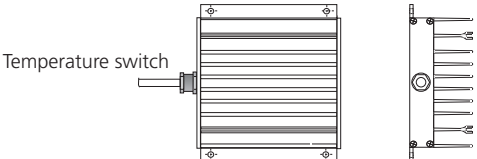
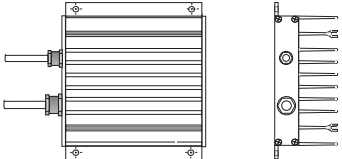
Protection classes			
Protection class	Setting	Series	
		155	156
IP65 / IP66		X	X
IP65 / IP66 or higher with temperature switch		X	X

## Useful facts about REOhm resistors

If installed on a non or poor heat-conducting material, the performance must be checked due to the reduced heat dissipation. When mounting vertically, it is essential to ensure that the connections or terminals are located on the underside of the resistor. An installation which has the connections on the uppermost side is not allowed! If several resistors are mounted one above the other, mutual interference must be taken into account. Here the compliance with the above mentioned ambient conditions must be observed and the

installation conditions checked on site. When mounted directly on a heat sink or cooling surface, the continuous power of the resistor can be increased or the surface temperature reduced. Depending on the type and size of the cooling surface / heat sink, the output can be increased by a factor of 1.5 - 4. However, this must be checked in individual cases, whereby the specified ambient conditions still apply.

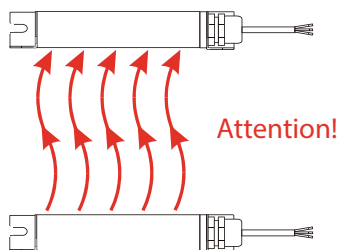
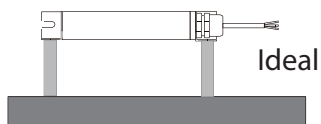

**Attention!**  
Mutual interference

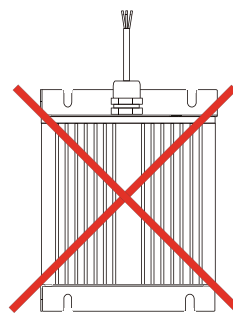

**Incorrect**  
Connection on top

**Correct**  
Bottom connection

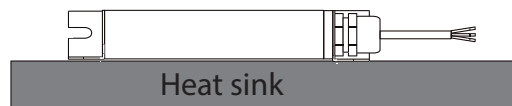
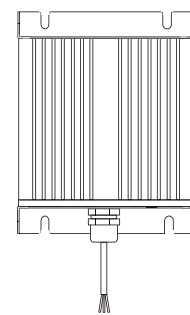

Power increase by factor 1.5 - 4 possible

# Useful facts about REOhm resistors

## Calculation of continuous power

If the kinetic energy  $E_{kin}$  emitted to the braking resistor during braking is known, the continuous power can be determined directly from the amount of energy and the cycle time.

$$P = E_{kin} / SD$$

$P$  = Continuous power  
 $E_{kin}$  = Kinetic energy  
 $SD$  = Cycle time

If the kinetic energy is not known, the duty cycle  $ED$  and the cycle time  $SD$  are required.

$$ED[\%] = \frac{ED[s]}{SD[s]} \cdot 100$$

$ED$  = Duty cycle  
 $SD$  = Cycle time

The continuous power for a duty cycle of 10% can be calculated as follows:

$$P = P_{max} \times 10\%$$

At a duty cycle of 50% the result is:

$$P = P_{max} \times 50\%$$

The continuous power ( $P$ ) is therefore smaller than the maximum pulse power ( $P_{max}$ ) by a corresponding factor. The calculations at REO refer to intermittent braking at a cycle time of 120 seconds.

Due to their special wound construction and heat conductive insulating material, REOhm braking resistors ensure that the heat can be quickly transported to the surface during pauses, which allows the heat to dissipate over a longer period of time. However, due to the rapid cooling of the winding, pulses can always be absorbed without compromising safety or the resistors performance. The REOhm braking resistors of the standard series are designed for a duty cycle of 5% -100%. Smaller duty cycles are also possible on request.

Load diagram for air-cooled resistors

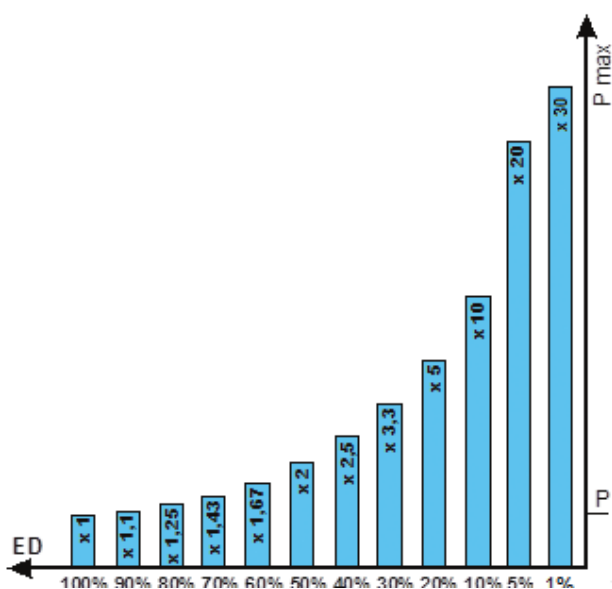

$SD$  = Cycle time max. 120 sek  
 $ED$  = Duty cycle

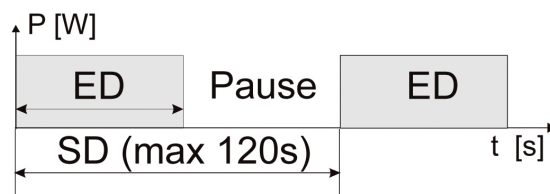



## REOhm Series BW 15X

In industry, the resistors have to work safely for many years under difficult environmental conditions. In addition to the permissible temperature range, the environmental conditions i.e. resistance to common railway pollutants such as vapours, gases, coal dust, oil or brake abrasion, represents a restriction of use. In addition, the penetration of moisture and foreign bodies, such as dust, must be prevented for reliable operation.

### Advantages

The REOhm resistors of the BW 15X series are characterized by high functional reliability and a long service life. Due to their special design, REOhm resistors offer very high mechanical protection and are not susceptible to vibrations and oscillations. Due to this design, the resistor can absorb higher pulse loads and dissipate them effectively. External environmental influences have very little effect on the resistor, i.e. they are less sensitive to moisture and dirt. Profile resistors emit low levels of audible noise.

### Resistor value / temperature dependence

The resistor value changes slightly depending on the winding temperature. This results in resistor changes of approx. +10% compared to the cooled state.

The performance data in the data sheets apply under the following operating conditions:

- Maximum ambient temperature 40 °C
- Unimpeded air flow to ensure cooling
- If the ambient temperature is higher than 40 °C, the continuous power must be reduced by 5% per 10K temperature increase.

The resistors are short-circuit proof and self-extinguishing. (All series except REOhm R)

The resistors are designed to convert electrical energy into heat, so heating of the vicinity and adjacent housing parts is unavoidable. It must be ensured that the cooling air flows in and out freely and that sufficient heat is dissipated via cooling surfaces.

### Protection classes

Depending on the design and construction, different degrees of protection can be provided. For protection class  $\leq$  IP20 the temperature increase at the hottest point of the resistor surface must not exceed 300K. For a higher degree of protection ( $>$  IP20), a maximum temperature increase of 200K applies at the hottest point of the resistor surface.

### Overheating Protection

It is possible to monitor the temperature of the resistor with a temperature switch. When a nominal temperature is exceeded, the temperature switch opens and triggers a signalling contact. The temperature switch is equipped with two cables ready for connection.

# Operating conditions

REOhm Series BW 15X	
Ambient temperature	-15 °C ... +70 °C Operating, storage and transport temperature Over 40°C Reduce continuous power Pd by 5% 10K
Max. relative humidity 5-85% non-condensing during operation, transport and storage.	
Installation altitude	0 ... 4000 m üNN over 1000 m Reduce continuous power Pd by 5% / 1000 m
Installation place	The installation site must correspond to the device characteristics specified in the „General data“. Flammable materials or substances must not be in the vicinity of the braking resistor. The heat generated by the braking resistor must be dissipated unhindered.
Mounting position	Vertically suspended with connections at the bottom or horizontal mounting
Installation clearances	Top > 200 mm Below > 100 mm Lateral > 25 mm

# General data

REOhm Series BW 15X	
Conformity	CE low voltage directional
Temperature switches	Normally closed version, 200 °C
Switching capacity	250 V AC / 0,5 A
Insulation resistance > 5 MΩ / bei 1000 V	

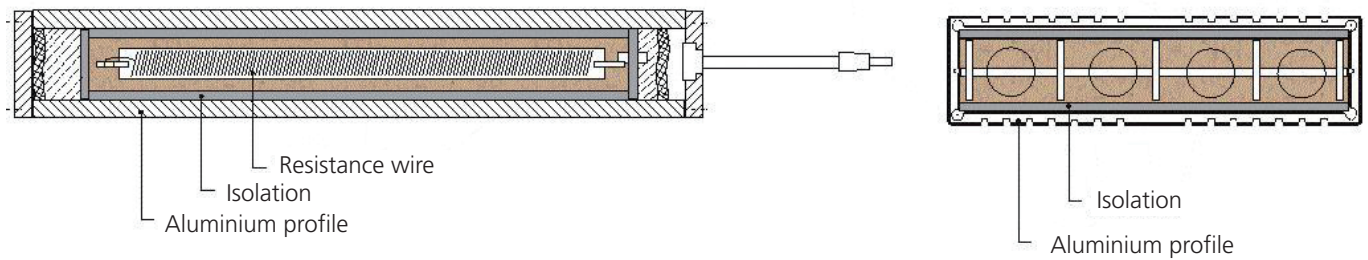



## Compact Braking resistor

**BW 155** Protection class IP65 / IP66

BW 155/600 - 2500 W/xx

### Advantages

- Small dimensions at high output
- Fast connection
- Short-circuit proof
- Very good heat dissipation
- High-resistance at overload
- Options available with terminal covers and temperature switches
- Installation also possible outside the control cabinet

Compact Braking resistor BW 155

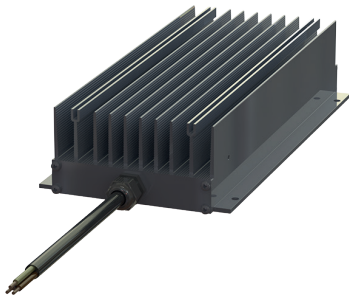

## Technical data

Compact Braking resistor BW 155			
Type	Resistance R [Ohm] to the E12 series*	Continuous output P [W]	max. operating voltage U [V]
BW 155 / 1000 / IP..	1 - 820	600	900
BW 155 / 1200 / IP..	1,8 - 820	800	900
BW 155 / 1500 / IP..	2,2 - 820	1000	900
BW 155 / 2000 / IP..	2,7 - 820	1500	900
BW 155 / 2500 / IP..	3,3 - 820	1875	900
BW 155 / 3000 / IP..	3,9 - 820	2250	900
BW 155 / 3500 / IP..	4,7 - 820	2500	900

\*Other resistance values on request.

## Mechanical data

Compact Braking resistor BW 155								
Type	Dimensions							Connection
	B1 [mm]	B2 [mm]	H [mm]	L1 [mm]	L2 [mm]	L3 [mm]	D [mm]	
BW 155 / 1000 / IP..	175	165	75	182	120	250	6,5	IP65 / 66 shielded connecting wire 3x1,5 mm <sup>2</sup>
BW 155 / 1200 / IP..	175	165	75	242	180	250	6,5	
BW 155 / 1500 / IP..	175	165	75	342	280	250	6,5	
BW 155 / 2000 / IP..	175	165	75	542	500	250	6,5	
BW 155 / 2500 / IP..	175	165	75	672	630	250	6,5	IP65 / 66 shielded connecting wire 3x2,5 mm <sup>2</sup>
BW 155 / 3000 / IP..	175	165	75	762	720	250	6,5	
BW 155 / 3500 / IP..	175	165	75	872	830	250	6,5	

Applications: Braking resistor for drives with frequency converters of small to medium output, installation close to the frequency converter:  
Test voltage: 2,5 kV DC

Circuit example

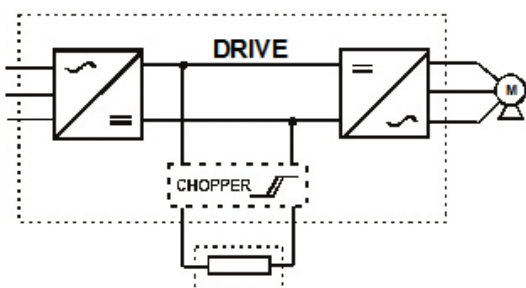

Dimension drawing

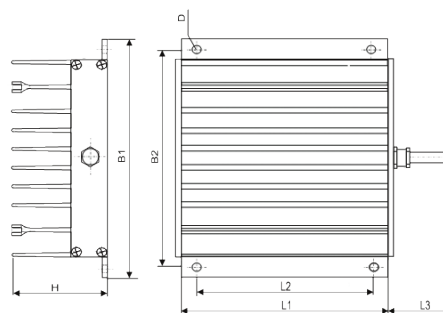



## Compact Braking resistor BW 155 - combination

Protection class IP65 / IP66

BW 155/3.000 - 22.5000 W/xx

### Advantages

- Small dimensions at high output
- Fast connection
- Short-circuit proof
- Very good heat dissipation
- High-resistance at overload
- Options available with terminal covers and temperature switches
- Installation also possible outside the control cabinet

Compact Braking resistor BW 155-combination

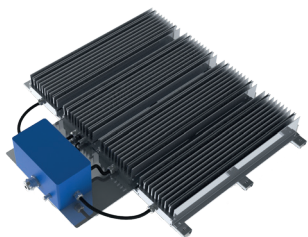

### Technical data

Compact Braking resistor BW 155 - combination			
Type	Resistance R [Ohm] to the E12 series*	Continuous output P [W]	max. operating voltage U [V]
BW 155 / 4000 / IP..	1- 180	3.000	900
BW 155 / 5000 / IP..	1 - 150	3750	900
BW 155 / 6000 / IP..	1 - 120	4500	900
BW 155 / 7500 / IP..	1 - 100	5600	900
BW 155 / 9000 / IP..	1 - 82	6750	900
BW 155 / 10000 / IP..	1 - 68	7500	900
BW 155 / 12000 / IP..	1 - 56	9000	900
BW 155 / 15000 / IP..	1 - 47	11250	900
BW 155 / 18000 / IP..	1,5 - 39	13500	900
BW 155 / 22000 / IP..	1,5 - 33	16800	900
BW 155 / 24000 / IP..	1,8 - 33	18000	900
BW 155 / 27000 / IP..	2,2 - 27	20250	900
BW 155 / 30000 / IP..	2,2 - 27	22500	900

\*Other resistance values on request.

## Mechanical data

Compact Braking resistor BW 155 - combination									
Type	Dimensions						Cable gland	Connection clamp	Design type
	L1 [mm]	L2 [mm]	B1 [mm]	H1 [mm]	H2 [mm]	D [mm]			
BW 155 / 4000 / IP...	750	500	420	390	95	8,5	M25	10 mm <sup>2</sup>	BF 1
BW 155 / 5000 / IP...	880	630	420	390	95	8,5	M25	10 mm <sup>2</sup>	BF 1
BW 155 / 6000 / IP...	970	720	420	390	95	8,5	M25	10 mm <sup>2</sup>	BF 1
BW 155 / 7500 / IP...	880	630	590	560	95	8,5	M25	10 mm <sup>2</sup>	BF 2
BW 155 / 9000 / IP...	970	720	590	560	95	8,5	M25	10 mm <sup>2</sup>	BF 2
BW 155 / 12000 / IP...	970	720	770	740	95	8,5	M32	16 mm <sup>2</sup>	BF 3
BW 155 / 15000 / IP...	970	720	940	910	95	8,5	M32	16 mm <sup>2</sup>	BF 4
BW 155 / 18000 / IP...	970	720	2x590	2x560	95	8,5	M32	35 mm <sup>2</sup>	2x BF2
BW 155 / 24000 / IP...	970	720	2x770	2x740	95	8,5	M32	35 mm <sup>2</sup>	2x BF3
BW 155 / 27000 / IP...	970	720	3x590	3x590	95	8,5	M32	35 mm <sup>2</sup>	2x BF2
BW 155 / 30000 / IP...	970	720	2x940	2x910	95	8,5	M32	35 mm <sup>2</sup>	2x BF4

Applications: Braking resistor for drives with frequency converters of high output, installation close to the frequency converter: Test voltage: 2,5 kV AC, Ambient temperature: -10...+40 °C

For low resistance values, the conductor cross-section is adapted to the current.

Circuit example

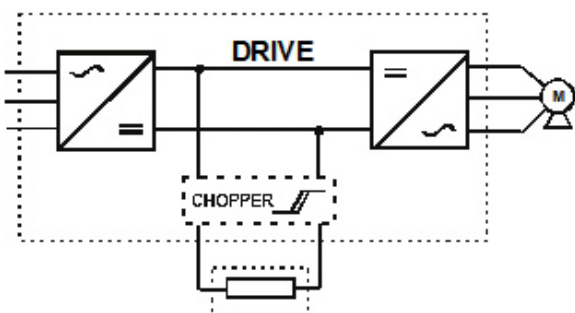

Design IP65

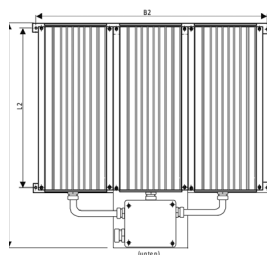

Dimension drawing, Design 1

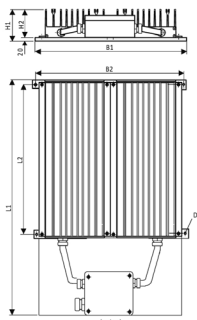

Dimension drawing, Design 2

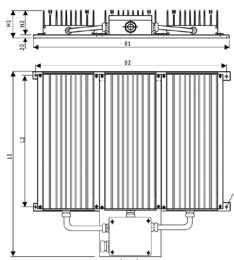

Dimension drawing, Design 3

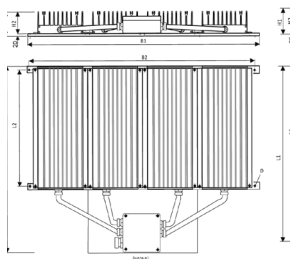

Dimension drawing, Design 4

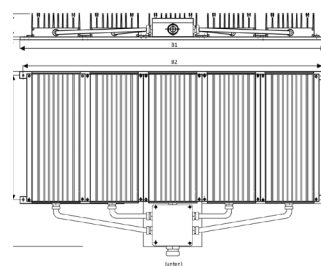



## Compact Braking resistor

**BW 156** Protection class IP65 / IP66

BW 156/300 - 800 W/xx

### Advantages

- Small dimensions at high output
- Fast connection
- Short-circuit proof
- Very good heat dissipation
- High-resistance at overload
- Options available with terminal covers and temperature switches
- Installation also possible outside the control cabinet

Compact Braking resistor BW 156

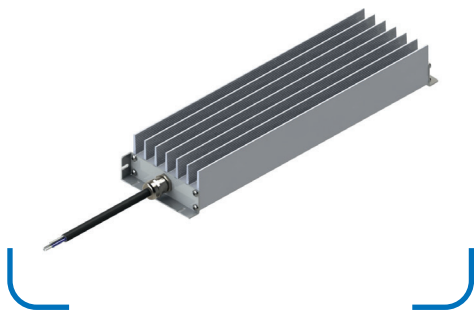

## Technical data

Compact Braking resistor BW 156			
Typ	Resistance R [Ohm] to the E12 series*	Continuous output P [W]	max. operating voltage U [V]
BW 156 / 400 / IP...	1 - 820	300	900
BW 156 / 600 / IP...	1 - 820	400	900
BW 156 / 800 / IP...	1,8 - 820	500	900
BW 156 / 1000 / IP...	2,2 - 820	600	900
BW 156 / 1200 / IP...	2,2 - 820	700	900
BW 156 / 1500 / IP...	2,7 - 820	800	900

Applications: Braking resistor for drives with frequency converters of small to medium output. Installation in or outside of the control cabinet is possible: Test voltage 2,5 kV AC

\*Other resistance values on request.

## Mechanical data

Compact Braking resistor BW 156									
Type	Dimensions								Connection
	L1 [mm]	L2 [mm]	L3 [mm]	L4 [mm]	B1 [mm]	B2 [mm]	H [mm]	D [mm]	
BW 156 / 400 / IP...	174	159	140	500	103	70	50	4,5	IP65 / 66 shielded connecting wire 3x1,5 mm <sup>2</sup>
BW 156 / 600 / IP...	234	219	200	500	103	70	50	4,5	
BW 156 / 800 / IP...	304	289	270	500	103	70	50	4,5	
BW 156 / 1000 / IP...	374	359	340	500	103	70	50	4,5	
BW 156 / 1200 / IP...	454	439	420	500	103	70	50	4,5	
BW 156 / 1500 / IP...	604	589	570	500	103	70	50	4,5	

Circuit example

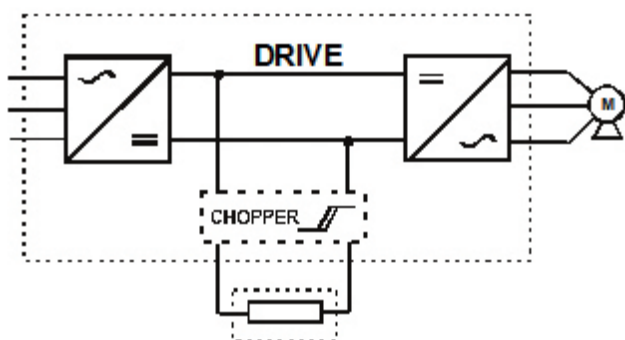

Dimension drawing

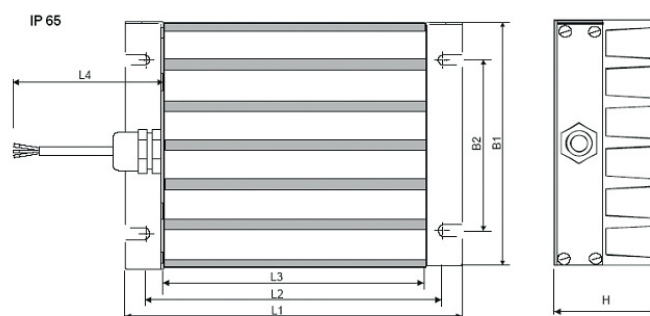

## Compact Braking resistor

**BWD 158** Protection class IP65 / IP66

BW D 158/1000 - 60.000 W/xx

### Advantages

- Very compact construction
- Use also possible at higher ambient temperatures
- Optimised cooling for high ratings
- Very low enclosure overtemperature (<50 °C)
- Suitable for standard cooling fluids (water/glycol)
- high protection class up to IP66
- Operating pressure of the cooling circuit up to 4 bar (test pressure 10 bar)
- Needs very little space in the control cabinet

Compact Braking resistor BWD 158

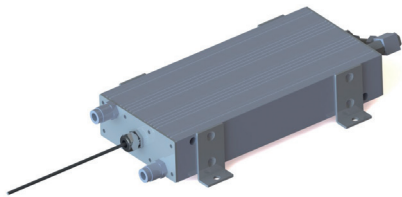

### Technical data

Compact Braking resistor BWD 158			
Type	Resistance values R [Ohm]*	Continuous output P [W]	max. operating voltage U [V]
BW D 158 / 1000	2,5 - 100	1000	1000
BW D 158 / 2000	50 - 200	2.000	1000
BW D 158 / 3000	10 - 200	3.000	1000
BW D 158 / 5000	10 - 200	5.000	1000
BW D 158 / 6000	10 - 200	6.000	1000
BW D 158 / 10000	6 - 500	10.000	1000
BW D 158 / 15000	4 - 600	15.000	1000
BW D 158 / 20000	3 - 600	20.000	1000
BW D 158 / 30000	2,1 - 750	30.000	1000
BW D 158 / 45000	2,1 - 800	45.000	1000
BW D 158 / 60000	2 - 850	60.000	1000

Applications: Drive technology, test beds, E-Mobility, railway engineering

\*Other resistance values on request.



# Mechanical data

Compact Braking resistor BWD 158									
Type	Dimensions						Connection		Design type
	L1 [mm]	L2 [mm]	L3 [mm]	B1 [mm]	B2 [mm]	H [mm]	Cable gland	Clamp	
BW D 158 / 3000	320	213	500	190	175	68	M20	6 mm <sup>2</sup>	BF1
BW D 158 / 5000	450	343	500	190	175	68	M20	6 mm <sup>2</sup>	BF1
BW D 158 / 6000	550	443	500	190	175	68	M20	6 mm <sup>2</sup>	BF1
BW D 158 / 10000	680	343	265	176	156	170	M25	10 mm <sup>2</sup>	BF2
BW D 158 / 15000	680	343	265	245	225	170	M32	10 mm <sup>2</sup>	BF3
BW D 158 / 20000	680	343	265	2x176	2x156	170	M32	10 mm <sup>2</sup>	2xBF2
BW D 158 / 30000	680	343	265	2x245	2x225	170	M32	10 mm <sup>2</sup>	2xBF3
BW D 158 / 45000	680	343	265	3x245	3x225	170	M32	16 mm <sup>2</sup>	3xBF3
BW D 158 / 60000	680	343	265	4x245	4x225	170	M32	16 mm <sup>2</sup>	4xBF3

Circuit example

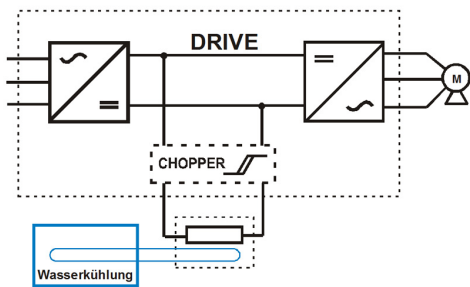

Dimension drawing, Design 1

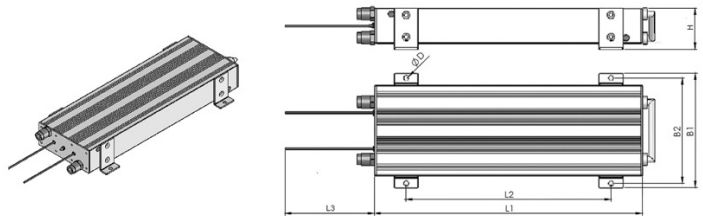

Dimension drawing, Design 2

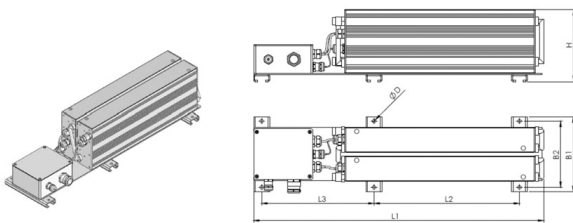

Dimension drawing, Design 3

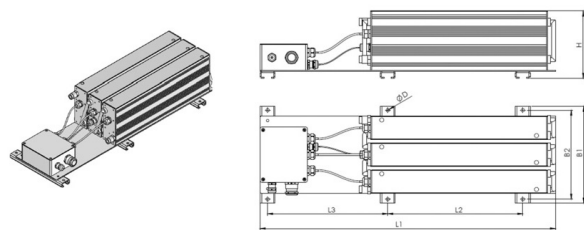

## Compact Braking resistor

### BW D 330 **Protection class IP67**

BW D 330/15.000 - 60.000 W/xx

Liquid-cooled braking resistor,  
max continuous output: 60.000 W

The REO braking resistor converts excess braking energy into useful heat and is thus ideally suitable for electrical or hybrid drives. The water cooling makes an additional space saving of up to 88% possible as compared to a traditional air-cooled braking resistor. As an extra feature, the resistor can easily be connected with drip-free quick fasteners.

## Advantages

- 88% space saving
- Non-drip quick-release connectors
- Liquid Cooling
- Low weight
- Low surface temperature

Compact Braking resistor BW D 330

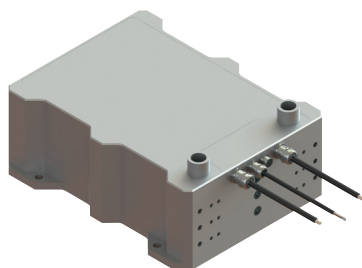

## Technical data

Compact Braking resistor BW D 330			
Type	Resistance values [Ohm]*	Continuous output [W]	Operating voltage [V]
BW D 330 / 15.000	4,2 - 43,5	15000	800
BW D 330 / 30.000	2,1 - 21,5	30000	
BW D 330 / 45.000	1,4 - 14,5	45000	
BW D 330 / 60.000	1,6 - 11	60000	

Applications: Electric mobility, hybrid vehicles, wind power, industrial applications

\*Other resistance values on request.

## Mechanical data

Compact Braking resistor BW D 330							
Type	Dimensions						
	L1 [mm]	L2 [mm]	B1 [mm]	B2 [mm]	D1 [mm]	D2 [mm]	H1 [mm]
D 330 / 15.000	390	250	315	285	12,5	G3/4	57
D 330 / 30.000	390	250	315	285	12,5	G3/4	87
D 330 / 45.000	390	250	315	285	12,5	G3/4	117
D 330 / 60.000	390	250	315	285	12,5	G3/4	147

Dimension drawing

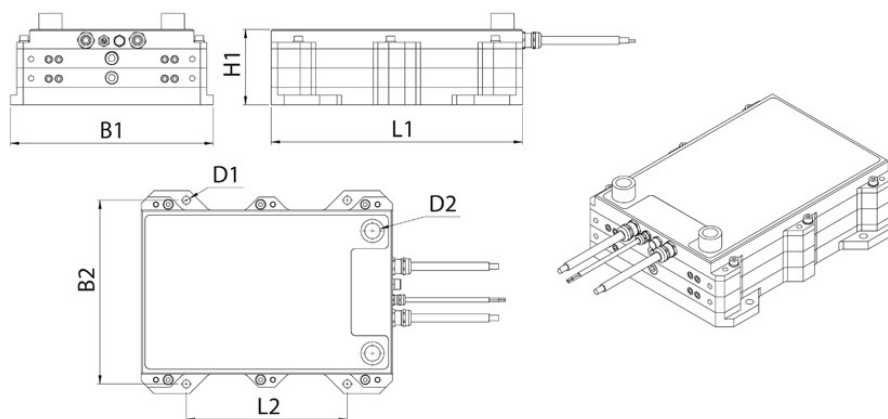



## Applicable standards

Applicable standards	
Standards	Explanation
DIN IEC 68 Teil 1 und 2 - 6	Environmental testing
IEC 60322 (DIN EN 60322)	Railway applications – Electric equipment for rolling stock– Rules for power resistors of open construction
IEC 61373	Railway applications – Rolling stock equipment – Shock and vibration tests
DIN EN 61373	Railway applications – Rolling stock equipment – Shock and vibration tests
DIN WDE 0160 und VDE 0535	Electronic equipment for use in power installations
DIN EN 50124	Railway applications – Insulation coordination – Part 1: Basic requirements; Clearances and creepage distances for all electrical and electronic equipment
DIN EN 50125-1	Railway applications - Environmental conditions for equipment – Part 1: Equipment on board rolling stock
DIN EN 50155 BN411002	Railway applications - Electronic equipment used on rolling stock
DIN EN 60068	Environmental testing– Part 2: Tests – Test group A: Coldness
DIN EN 60068	Environmental testing– Part 2: Tests – Test group B: Dry heat
DIN EN 60068	Environmental testing– Part 2: Tests – Testing Ka: Salt spray
DIN EN 60068	Environmental testing– Part 2: Tests – Testing Db: Moist heat, cyclical
DIN EN 60529	Degrees of protection provided by enclosures (IP code)
DIN EN 61140	Protection against electrical shocks
EN 60721-3-5	Classification of environmental conditions – Classification of groups of environmental parameters and their severities. – Ground vehicle installations



REO AG  
Brühler Straße 100 · D-42657 Solingen  
Tel.: +49 (0)212 8804 0 · Fax: +49 (0)212 8804 188

E-Mail: [info@reo.de](mailto:info@reo.de)  
Internet: [www.reo.de](http://www.reo.de)



#### **DIVISIONS:**

##### **REO Vibratory Feeding and Power Electronics Division**

Brühler Straße 100 · D-42657 Solingen  
Tel.: +49 (0)212 8804 0 · Fax: +49 (0)212 8804 188  
E-Mail: [info@reo.de](mailto:info@reo.de)

##### **REO Train Technologies Division**

Erasmusstraße 14 · D-10553 Berlin  
Tel.: +49 (0)30 3670236 0 · Fax: +49 (0)30 3670236 10  
E-Mail: [zentrale.berlin@reo.de](mailto:zentrale.berlin@reo.de)

##### **REO Drives Division**

Holzhausener Straße 52 · D-16866 Kyritz  
Tel.: +49 (0)33971 485 0 · Fax: +49 (0)33971 485 90  
E-Mail: [zentrale.kyritz@reo.de](mailto:zentrale.kyritz@reo.de)

##### **REO Medical and Current Transformer Division**

Schuldholzinger Weg 7 · D-84347 Pfarrkirchen  
Tel.: +49 (0)8561 9886 0 · Fax: +49 (0)8561 9886 40  
E-Mail: [zentrale.pfarrkirchen@reo.de](mailto:zentrale.pfarrkirchen@reo.de)

##### **REO Test and PowerQuality Division**

Brühler Straße 100 · D-42657 Solingen  
Tel.: +49 (0)212 8804 0 · Fax: +49 (0)212 8804 188  
E-Mail: [info@reo.de](mailto:info@reo.de)

#### **PRODUCTION + SALES:**

##### **India**

REO GPD INDUCTIVE COMPONENTS PVT. LTD  
E-Mail: [info@reogpd.com](mailto:info@reogpd.com) · Internet: [www.reo-ag.in](http://www.reo-ag.in)

##### **USA**

REO-USA, Inc.  
E-Mail: [info@reo-usa.com](mailto:info@reo-usa.com) · Internet: [www.reo-usa.com](http://www.reo-usa.com)

#### **SALES:**

##### **China**

REO Shanghai Inductive Components Co., Ltd  
E-Mail: [info@reo.cn](mailto:info@reo.cn) · Internet: [www.reo.cn](http://www.reo.cn)

##### **France**

REO VARIAC S.A.R.L.  
E-Mail: [reovariac@reo.fr](mailto:reovariac@reo.fr) · Internet: [www.reo.fr](http://www.reo.fr)

##### **Great Britain**

REO (UK) Ltd.  
E-Mail: [main@reo.co.uk](mailto:main@reo.co.uk) · Internet: [www.reo.co.uk](http://www.reo.co.uk)

##### **Italy**

REO ITALIA S.r.l.  
E-Mail: [info@reoitalia.it](mailto:info@reoitalia.it) · Internet: [www.reoitalia.com](http://www.reoitalia.com)

##### **Poland**

REO CROMA Sp.zo.o  
E-Mail: [croma@croma.com.pl](mailto:croma@croma.com.pl) · Internet: [www.croma.com.pl](http://www.croma.com.pl)

##### **Spain**

REO ESPAÑA 2002 S.A.  
E-Mail: [info@reospain.com](mailto:info@reospain.com) · Internet: [www.reospain.com](http://www.reospain.com)

##### **Switzerland**

REO ELEKTRONIK AG  
E-Mail: [info@reo.ch](mailto:info@reo.ch) · Internet: [www.reo.ch](http://www.reo.ch)

##### **Turkey**

REO TURKEY ELEKTRONIK San. ve Tic. Ltd. Şti.  
E-Mail: [info@reo-turkey.com](mailto:info@reo-turkey.com) · Internet: [www.reo-turkey.com](http://www.reo-turkey.com)

##### **United Arab Emirates**

REO INDUCTIVE COMPONENTS FZCO  
E-Mail: [info@reo-middle-east.com](mailto:info@reo-middle-east.com)  
Internet: [www.reo-middle-east.com](http://www.reo-middle-east.com)